

Thank you for using our products.
INSTALLATION INSTRUCTIONS
SERIES E60 ROUND SPEAKERS AND SPEAKER STROBES

Use this product according to this instruction manual. Please keep this instruction manual for future reference.

GENERAL:

Series E60 Round Speakers and Speaker Strobes are UL Listed under Standard 1971 for Signaling Devices for the Hearing Impaired and UL Standard 1480 for Speaker Appliances. E60 Speaker Strobes with amber, blue, green or red lens are UL Listed under Standard 1638 (Visual Signaling Appliance) for Private Mode Emergency and General Utility Signaling. They are designed for multiple power requirements with high dBA output at each power tap. All models offer a choice of field selectable taps, 1/8W to 2W, for either 25.0VRMS or 70.0VRMS audio systems. The design incorporates a high efficiency speaker for maximum output at minimum power across a frequency range of 400Hz to 4000Hz, and features a sealed back construction for extra protection and improved audibility. The Series E60 appliances also incorporate a speaker mounting plate attached to the speaker for ease of installation. The Speaker Strobes can provide a non-synchronized strobe appliance when connected directly to a Fire Alarm Control Panel (FACP), or provide a synchronized strobe appliance when used in conjunction with a Sync Module (SM), Dual Sync Module (DSM), or Wheelock power supplies. The strobes use a xenon flashtube with solid state circuitry enclosed in a polycarbonate lens to provide maximum visibility and reliability for effective visible signaling. The E60-24MCW and E60-24MCWH Speaker Strobes are for wall mounting only. The E60-24MCC and E60-24MCCH Speaker Strobes are for ceiling mounting only. All models are Listed for indoor use only with the back boxes specified in these instructions (see Wiring and Mounting Information).

⚠ WARNING: PLEASE READ THESE INSTRUCTIONS CAREFULLY. FAILURE TO COMPLY WITH ANY OF THE FOLLOWING INSTRUCTIONS, CAUTIONS AND WARNINGS COULD RESULT IN IMPROPER APPLICATION, INSTALLATION AND/OR OPERATION OF THESE PRODUCTS IN AN EMERGENCY SITUATION, WHICH COULD RESULT IN PROPERTY DAMAGE AND SERIOUS INJURY OR DEATH TO YOU AND/OR OTHERS.

SPECIFICATIONS:

<i>Table 1: UL Listed Models and Ratings</i>										
Model	Voltage (VRMS)	Speaker					Regulated Voltage (VDC/VRMS)	Strobe		Mounting Options
		dBA at 10 Feet (Rated Watts)						Voltage Range (VDC/VRMS)	Candela	
		1/8	1/4	1/2	1	2				
E60	25/70	77.0	79.5	82.5	85.0	88.0	----	----	----	A
E60-24MCC	25/70	77.0	79.5	82.5	85.0	88.0	24	16-33.0	15/30/75/95	B
E60-24MCCH	25/70	77.0	79.5	82.5	85.0	88.0	24	16-33.0	115/177	B
E60-24MCW	25/70	77.0	79.5	82.5	85.0	88.0	24	16-33.0	15/30/75/110	B
E60-24MCWH	25/70	77.0	79.5	82.5	85.0	88.0	24	16-33.0	135/185	B

NOTES:

1. Strobes will produce 1 flash per second over the "Regulated Voltage" range.
2. Strobes with clear and amber lens meet the required light distribution patterns defined in UL 1971.
3. Candela ratings listed in Table 1 are rated for clear lens. Derate approximately 25% for amber, 55% for green, 70% for blue and 80% for red.
4. All models are UL Listed for indoor use with a temperature range of +32°F to +120°F (0°C to +49°C) and maximum humidity of 85% RH. The effect of shipping and storage temperatures shall not adversely affect the performance of the appliance when it is stored in the original cartons and is not subjected to misuse or abuse.
5. The maximum supervision voltage is 33 volts DC.
6. Frequency range of speakers is 400-4000Hz.

⚠ CAUTION: Always operate audio amplifiers and speakers within their specified ratings. Excessive input may distort sound quality and may damage audio equipment. Do not exceed 100% of speaker input voltage per UL 1480. Improper input voltage can damage speaker. If distortion is heard, check for clipping of the audio appliance with an oscilloscope and reduce the amplifier input level or gain level to eliminate any clipping.

⚠ WARNING: CANDELA SETTING WILL DETERMINE THE CURRENT DRAW OF THE PRODUCT.

<i>Table 2: UL Current Ratings with Strobe Only</i>							
E60-MCC/E60-MCCH Maximum RMS Current (AMPS)							
UL Voltage		15cd	30cd	75cd	95cd	115cd	177cd
DC	16-33VDC	0.065	0.105	0.189	0.249	0.300	0.420
FWR	16-33VRMS	0.110	0.170	0.280	0.375	0.455	0.645
E60-MCW/E60-MCWH Maximum RMS Current (AMPS)							
UL Voltage		15cd	30cd	75cd	110cd	135cd	185cd
DC	16-33VDC	0.060	0.092	0.165	0.220	0.300	0.420
FWR	16-33VRMS	0.102	0.155	0.253	0.347	0.455	0.645

⚠ CAUTION: These strobes are UL Listed as "Regulated". They are intended to be used with FACP's whose notification circuits are UL Listed as "Regulated." These appliances shall not be used on UL Listed "Special Application" notification circuits unless the appliances are identified to be compatible in the installation instructions of the FACP or unless the FACP is identified to be compatible in this instruction manual.

⚠ WARNING: THESE STROBES WERE TESTED TO THE REGULATED VOLTAGE LIMITS OF 16.0-33.0 VOLTS FOR 24V MODELS USING FILTERED DC OR UNFILTERED FULL-WAVE-RECTIFIED VOLTAGE. DO NOT APPLY VOLTAGE OUTSIDE OF THIS RANGE.

⚠ WARNING: CHECK THE MINIMUM AND MAXIMUM OUTPUT OF THE POWER SUPPLY AND STANDBY BATTERY AND SUBTRACT THE VOLTAGE DROP FROM THE CIRCUIT WIRING RESISTANCE TO DETERMINE THE APPLIED VOLTAGE TO THE STROBES. THE MAXIMUM WIRE IMPEDANCE BETWEEN STROBES SHALL NOT EXCEED 35 OHMS.

⚠ CAUTION: Strobes are not designed to be used on coded systems in which the applied voltage is cycled on and off.

⚠ WARNING: MAKE SURE THAT THE TOTAL RMS CURRENT REQUIRED BY ALL APPLIANCES THAT ARE CONNECTED TO THE SYSTEM'S PRIMARY AND SECONDARY POWER SOURCES, NOTIFICATION APPLIANCE CIRCUITS, SM, DSM SYNC MODULES, OR WHEELLOCK POWER SUPPLIES DOES NOT EXCEED THE POWER SOURCES' RATED CAPACITY OR THE CURRENT RATINGS OF ANY FUSES ON THE CIRCUITS TO WHICH THESE APPLIANCES ARE WIRED. OVERLOADING POWER SOURCES OR EXCEEDING FUSE RATINGS COULD RESULT IN LOSS OF POWER AND FAILURE TO ALERT OCCUPANTS DURING AN EMERGENCY, WHICH COULD RESULT IN PROPERTY DAMAGE AND SERIOUS INJURY OR DEATH TO YOU AND/OR OTHERS.

WIRING AND MOUNTING INFORMATION:

⚠ CAUTION: The following figures show the maximum number of field wires (conductors) that can enter the backbox used with each mounting option. If these limits are exceeded, there may be insufficient space in the backbox to accommodate the field wires and stresses from the wires could damage the product. Check that the installed product will have sufficient clearance and wiring room prior to installing backboxes and conduit, especially if sheathed multiconductor cable or 3/4" conduit fittings are used.

Although the limits shown for each mounting option comply with the National Electrical Code (NEC), Cooper Wheelock recommends use of the largest backbox option shown and the use of approved stranded field wires, whenever possible, to provide additional wiring room for easy installation and minimum stress on the product from wiring.

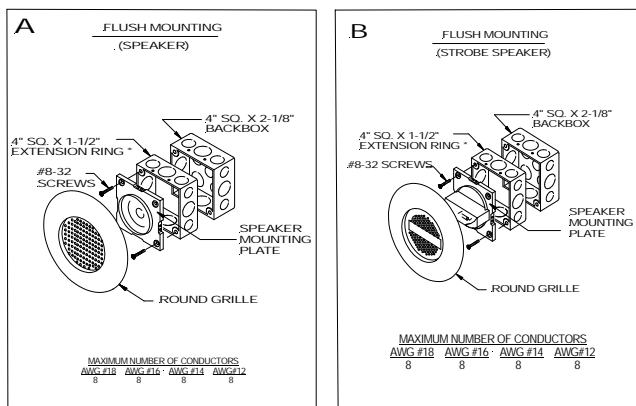
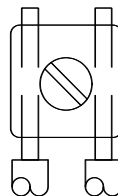
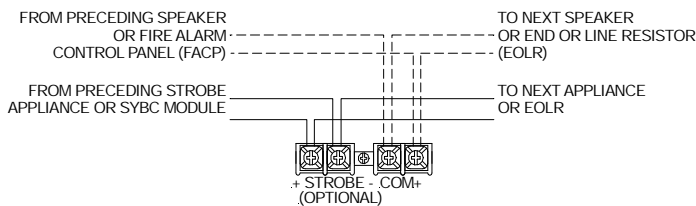

Figure 1:

Figure 2:



- This model has in-out wiring terminals that accept two #12 to #18 American Wire Gauge (AWG) wires at each screw terminal. Strip leads 3/8 inches and connect to screw terminals.
- Break all in-out wire runs on supervised circuits to assure integrity of circuit supervision as shown in Figure 2. The polarity shown in the wiring diagrams is for operation of the appliances.

* Refer to Sync Module instruction sheets SM (P83123), DSM (P83177) or Wheelock's Power Supplies for additional information.

GROUNDING: Connect ground wire to backbox. Install signaling appliance to backbox using mounting screws provided.

⚠ WARNING: CHECK ELECTRICAL RATINGS SPECIFIED IN TABLES 1 AND 2 (AS APPROPRIATE) TO ENSURE PROPER INPUT. BE SURE THAT SPEAKER WIRING IS CONNECTED TO SPEAKER TERMINALS ONLY AND STROBE WIRING IS CONNECTED TO STROBE TERMINALS ONLY. CHECK TO INSURE THAT WIRING AT FACP IS CORRECT. IMPROPER ELECTRICAL INPUT CAN DAMAGE THE PRODUCT OR CAUSE IT TO MALFUNCTION, WHICH COULD RESULT IN PROPERTY DAMAGE AND SERIOUS INJURY OR DEATH TO YOU AND/OR OTHERS.

Figure 3: Jumper plug is used to select tap settings which = dBA loudness. Figure 4: Tap Settings (Factory setting is 70V @ 1/2W (Tap F))

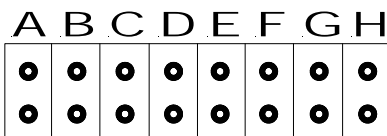
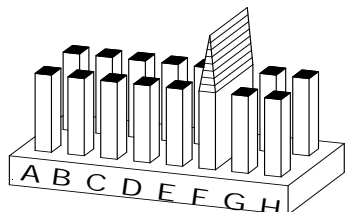

1. Each doubling of rated Watts increases sound output by 3 dBA. Field selectable input terminals are provided on each unit. The following wattage selections are available: 1/8W, 1/4W, 1/2W, 1W and 2W.
2. Each letter corresponds to a plug position of the header located on the printed circuit board. Select voltage and wattage as shown in Table 3 below.
3. A 1.5µF blocking capacitor for DC supervision of audio lines by the FACP is factory wired in series with the speaker input.

NOTE: Use needle nose pliers to pull and properly insert the jumper plug to the desired tap setting.

⚠ WARNING: THE SPEAKER AND SPEAKER STROBE APPLIANCES MUST BE FIELD SET TO THE DESIRED dBA SOUND OUTPUT LEVEL BEFORE THEY ARE INSTALLED. THIS IS DONE BY PROPERLY INSERTING JUMPER PLUGS IN ACCORDANCE WITH THESE INSTRUCTIONS. INCORRECT SETTINGS WILL RESULT IN IMPROPER PERFORMANCE, WHICH COULD RESULT IN PROPERTY DAMAGE AND SERIOUS INJURY OR DEATH TO YOU AND/OR OTHERS.

Position	25V	70V
A	2	-----
B	1	-----
C	1/2	-----
D	1/4	2
E	1/8	1
F	-----	1/2
G	-----	1/4
H	-----	1/8

Figure 5:

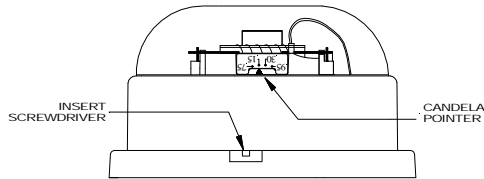

NOTE: The E60-24MCC comes pre-set at 15cd.
The E60-24MCW comes pre-set at 15cd.

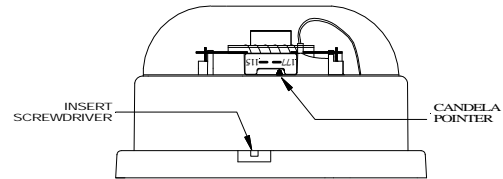

NOTE: The E60-24MCCH comes pre-set at 177cd.
The E60-24MCWH comes pre-set at 185cd.

⚠ WARNING: THE CANDELA SELECT SWITCH MUST BE FIELD SET TO THE REQUIRED CANDELA INTENSITY BEFORE INSTALLATION. WHEN CHANGING THE SETTING OF THE CANDELA SELECT SWITCH, MAKE CERTAIN THAT IT "CLICKS" IN PLACE. AFTER CHANGING THE CANDELA SETTING, THE APPLIANCE MUST BE RETESTED TO VERIFY PROPER OPERATION. IMPROPER SETTING OF THE CANDELA SELECT SWITCH, MAY RESULT IN OPERATION AT THE WRONG CANDELA, WHICH COULD RESULT IN PROPERTY DAMAGE AND SERIOUS INJURY OR DEATH TO YOU AND/OR OTHERS.

MOUNTING PROCEDURES:

1. All models can be flush mounted to a 4" square by 2-1/8" deep backbox with a 4" square 1-1/2" extension ring (Figure A). Mounting hardware is supplied.
2. Conduit entrances to the backbox should be selected to provide sufficient wiring clearance for the installed product. Do not pass additional wires (used for other than the signaling appliance) through the backbox. Such additional wires could result in insufficient wiring space for the signaling appliance.
3. When terminating field wires, do not use more lead length than required. Excess lead length could result in insufficient wiring space for the signaling appliance.
4. Use care and proper techniques to position the field wires in the backbox so that they use minimum space and produce minimum stress on the product. This is especially important for stiff, heavy gauge wires and wires with thick insulation or sheathing.
5. The speaker strobe has an integrated speaker mounting plate which must be oriented correctly before mounting the unit to the back box. See Figure B for correct strobe orientation.
6. To move selector switch, insert screwdriver into slot shown on the bottom side of the strobe. The setting is indicated by a pointer and can be seen on the bottom side of the lens. See Figure 5.
7. First mount the mounting plate to the backbox and fasten it with two screws. Next, snap the grille to the mounting plate. Make sure that the grille is secure and does not move.
8. To remove the grille, insert a small flat screwdriver into the slots on either side of grille to disengage the snaps. See Figure 6.

Figure 6: Grille Removal

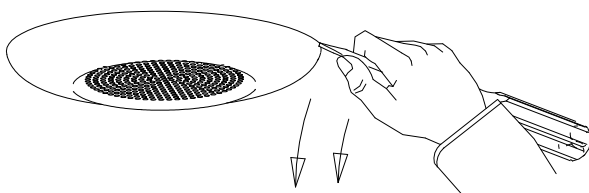

NOTE: Non strobe grille shown.

1. Hold flat screwdriver near the tip and insert the tip about 1/8" into one of the slots in the grille as shown.
2. Pull straight down as shown to pop off grille.

⚠ CAUTION: Prying, turning or pivoting with screwdriver in order to remove the grille may result in damage to ceiling.

⚠ WARNING: THE E60 SPEAKER STROBE APPLIANCE IS A "FIRE ALARM DEVICE - DO NOT PAINT."

⚠ WARNING: WHEN INSTALLING STROBES IN AN OPEN OFFICE OR OTHER AREAS CONTAINING PARTITIONS OR OTHER VIEWING OBSTRUCTIONS, SPECIAL ATTENTION SHOULD BE GIVEN TO THE LOCATION OF THE STROBES SO THAT THEIR OPERATING EFFECT CAN BE SEEN BY ALL INTENDED VIEWERS, WITH THE INTENSITY, NUMBER, AND TYPE OF STROBES BEING SUFFICIENT TO MAKE SURE THAT THE INTENDED VIEWER IS ALERTED BY PROPER ILLUMINATION, REGARDLESS OF THE VIEWER'S ORIENTATION. FAILURE TO DO SO COULD RESULT IN PROPERTY DAMAGE AND SERIOUS INJURY OR DEATH TO YOU AND/OR OTHERS.

The E60-24MCCH's 177cd setting and the E60-24MCWH's 135/185cd settings are Listed for use in sleeping or non-sleeping areas when installed in accordance with appropriate NFPA Standards and the Authority Having Jurisdiction.

⚠ WARNING: A SMALL POSSIBILITY EXISTS THAT THE USE OF MULTIPLE STROBES WITHIN A PERSON'S FIELD OF VIEW, UNDER CERTAIN CIRCUMSTANCES, MIGHT INDUCE A PHOTO-SENSITIVE RESPONSE IN PERSONS WITH EPILEPSY. STROBE REFLECTIONS IN A GLASS OR MIRRORED SURFACE MIGHT ALSO INDUCE SUCH A RESPONSE. TO MINIMIZE THIS POSSIBLE HAZARD, COOPER WHEELOCK STRONGLY RECOMMENDS THAT THE STROBES INSTALLED SHOULD NOT PRESENT A COMPOSITE FLASH RATE IN THE FIELD OF VIEW WHICH EXCEEDS FIVE (5) Hz AT THE OPERATING VOLTAGE OF THE STROBES. COOPER WHEELOCK ALSO STRONGLY RECOMMENDS THAT THE INTENSITY AND COMPOSITE FLASH RATE OF INSTALLED STROBES COMPLY WITH LEVELS ESTABLISHED BY APPLICABLE LAWS, STANDARDS, REGULATIONS, CODES AND GUIDELINES.

If this appliance is required to produce a distinctive three-pulse Temporal Pattern Fire Alarm Evacuation Signal (for total evacuation) in accordance with NFPA 72, the appliance must be used with a fire alarm control unit that can generate the temporal pattern signal. Refer to manufacturer's installation manual for details.

NOTE: NFPA 72/ANSI 117.1 conforms to ADAAG Equivalent Facilitation Guidelines in using fewer, higher intensity strobes within the same protected area.

⚠ CAUTION: Check the installation instructions of the manufacturers of other equipment used in the system for any guidelines or restrictions on wiring and/or locating Notification Appliance Circuits (NAC) and notification appliances. Some system communication circuits and/or audio circuits, for example, may require special precautions to assure electrical noise immunity (e.g. audio crosstalk).

NOTE: This equipment has been tested and found to comply with the limits for a Class B digital device, pursuant to Part 15 of the FCC Rules. These limits are designed to provide reasonable protection against harmful interference in residential installation. This equipment generates, uses and can radiate radio frequency energy and, if not installed and used in accordance with the instructions, may cause harmful interference to radio communications. However, there is no guarantee that interference will not occur in a particular installation. If this equipment does cause harmful interference to radio or television reception, which can be determined by turning the equipment off and on, the user is encouraged to try to correct the interference by one or more of the following measures: 1) Reorient or relocate the receiving antenna, 2) Increase the separation between the equipment and receiver, 3) Connect the equipment into an outlet on a circuit different from that to which the receiver is connected, and 4) Consult the dealer or an experienced radio/TV technician for help.

ANY MATERIAL EXTRAPOLATED FROM THIS DOCUMENT OR FROM COOPER WHEELOCK MANUALS OR OTHER DOCUMENTS DESCRIBING THE PRODUCT FOR USE IN PROMOTIONAL OR ADVERTISING CLAIMS, OR FOR ANY OTHER USE, INCLUDING DESCRIPTION OF THE PRODUCT'S APPLICATION, OPERATION, INSTALLATION AND TESTING IS USED AT THE SOLE RISK OF THE USER AND COOPER WHEELOCK WILL NOT HAVE ANY LIABILITY FOR SUCH USE.

Limited Warranty

Cooper Wheelock, Inc. products must be used within their published specifications and must be PROPERLY specified, applied, installed, operated, maintained, and operationally tested in accordance with these instructions at the time of installation and at least twice a year or more often in accordance with local, state and federal codes, regulations and laws. Specification, application, installation, operation, maintenance, and testing must be performed by qualified personnel for proper operation in accordance with all of the latest National Fire Protection Association (NFPA), Underwriters' Laboratories (UL), Underwriters' Laboratories of Canada (ULC), National Electrical Code (NEC), Occupational Safety and Health Administration (OSHA), local, state, county, province, district, federal and other applicable building and fire standards, guidelines, regulations, laws and codes including, but not limited to, all appendices and amendments and the requirements of the local authority having jurisdiction (AHJ). Cooper Wheelock, Inc. products when properly specified, applied, installed, operated, maintained, and operationally tested as provided above are warranted against mechanical and electrical defects for a period of three years from date of manufacture (as determined by date code). Correction of defects by Cooper Wheelock, Inc providing repairs or a replacement shall be at Cooper Wheelock, Inc.'s sole discretion and shall constitute fulfillment of all warranty obligations. The foregoing limited warranty shall immediately terminate in the event any part not furnished by Cooper Wheelock, Inc. is installed in the product. The foregoing limited warranty specifically excludes any software required for the operation of or included in a product. **COOPER WHEELOCK, INC. MAKES NO REPRESENTATION OR WARRANTY OF ANY OTHER KIND, EXPRESS, IMPLIED OR STATUTORY WHETHER AS TO MERCHANTABILITY, FITNESS FOR A PARTICULAR PURPOSE OR ANY OTHER MATTER.**

Users are solely responsible for determining whether a product is suitable for the user's purposes, or whether it will achieve the user's intended results. There is no warranty against damage resulting from misapplication, improper specification, abuse, accident, or other operating conditions beyond Cooper Wheelock, Inc.'s control.

Some Cooper Wheelock, Inc. products contain software. With respect to those products, Cooper Wheelock, Inc. does not warranty that the operation of the software will be uninterrupted or error-free or that the software will meet any other standard of performance, or that the functions or performance of the software will meet the user's requirements. Cooper Wheelock, Inc. shall not be liable for any delays, breakdowns, interruptions, loss, destruction, alteration, or other problems in the use of a product arising out of or caused by the software.

The liability of Cooper Wheelock, Inc. arising out of the supplying of a product, or its use, whether based on warranty, negligence, or otherwise, shall not in any case exceed the cost of correcting defects as stated in the limited warranty and upon expiration of the warranty period all such liability shall terminate. Cooper Wheelock, Inc. is not liable for labor costs incurred in removal, reinstallation, or for damage of any type whatsoever, including but not limited to, loss of profit or incidental or consequential damages. The foregoing shall constitute the sole remedy of the purchaser and the exclusive liability of Cooper Wheelock, Inc.

In no case will Cooper Wheelock, Inc.'s liability exceed the purchase price paid for a product.

Limitation of Liability

Cooper Wheelock, Inc.'s liability on any claim of any kind, including negligence, breach of warranty, or otherwise, for any loss or damage resulting from, arising out of, or connected with any contract, or from the manufacture, sale, delivery, resale, repair or use of any product shall be limited to the price applicable to the product or part thereof which gives rise to the claim. Cooper Wheelock, Inc.'s liability on any claim of any kind shall cease immediately upon the installation in the product of any part not furnished by Cooper Wheelock, Inc. In no event shall Cooper Wheelock, Inc. be liable for any claim of any kind unless it is proven that our product was a direct cause of such claim. **FURTHER, IN NO EVENT, INCLUDING IN THE CASE OF A CLAIM OF NEGLIGENCE, SHALL COOPER WHEELOCK, INC. BE LIABLE FOR INCIDENTAL, INDIRECT, SPECIAL OR CONSEQUENTIAL DAMAGES.** Some states do not allow the exclusion or limitation of incidental or consequential damages, so the preceding limitation may not apply to all purchasers.