

INSTALLATION INSTRUCTIONS
SERIES CH70-24MCWH CHIME STROBE
VERSION 2

IMPORTANT: All audible and visual signaling appliances must be installed in accordance with all applicable national and local fire alarm codes and any other required regulatory agencies.

GENERAL:

Series CH70-24MCWH Multi-Candela Electronic Chime Strobe is UL Listed under Standard 1971 for Signaling Devices for the Hearing Impaired and UL Standard 464 for Private Mode Audible Signal Appliances as well as CAN/ULC- S526-17 and CAN/ULC-S525-17. In Canada, the chime is for Dwelling Use Only. The CH70-24MCWH Chime Strobe is designed for low current draw and versatile performance. This model offers a choice of 1Hz, 2Hz, coded, or temporal code 3 (T3) operation, has adjustable sound level, and has a chime tone of 890Hz. The CH70-24MCWH Multi-Candela strobe provides four selectable light output intensities in one unit. This appliance also incorporates a chime mounting plate attached to the chime for ease of installation. The Chime Strobe model can provide a non-synchronized strobe appliance when connected directly to a fire alarm control panel (FACP), or provide a synchronized strobe appliance when connected to a notification appliance circuit running the Cooper Notification sync protocol. The chime tone can be synchronized as well using the same equipment.

The strobe uses a xenon flashtube with solid state circuitry enclosed in a polycarbonate lens to provide maximum visibility and reliability for effective visible signaling. The CH70-24MCWH is Listed for indoor use, wall mount only with the backboxes specified in these instructions (see wiring and mounting information).

The CH70-24MCWH model is UL/ULC Listed for indoor use with a temperature range of +32°F to +122°F (0°C to +50°C) and maximum humidity of 93% RH. The effect of shipping and storage temperatures shall not adversely affect the performance of the appliance when it is stored in the original cartons and is not subjected to misuse or abuse. NFPA 72/ANSI 117.1 conform to ADAAG Equivalent Facilitation Guidelines in using fewer, higher intensity strobes within the same protected area

NOTE: All **CAUTIONS** and **WARNINGS** are identified by the symbol **⚠** and printed in bold capital letters.

⚠ WARNING: THE CHIME APPLIANCE IS A "FIRE ALARM DEVICE - DO NOT PAINT."

SPECIFICATIONS:

Table 1: UL/ULC Listed Models and Rating						
Models	Operating Voltage (VDC VRMS)	Maximum RMS Current (Chime Only) Max	UL dBA at 10 Feet Reverberant		ULC dBA at 10ft Anechoic	
			Min	Max	Min	Max
CH70-24MCWH	16-33.0	0.022	46	64	58	76

Table 2: UL/ULC Current Ratings (Strobe Only)			
Maximum RMS Current (Amps)			
UL/ULC Voltage		135cd	185cd
DC	16-33 VDC	0.300	0.420
FWR	16-33 VDC	0.455	0.645

⚠ WARNING: CANDELA SETTING WILL DETERMINE THE CURRENT DRAW OF THE PRODUCT.

NOTES:

1. The strobe will produce 1 flash per second over the Input Voltage range.
2. The strobes meet the required light distribution patterns defined in UL 1971.
3. The chime produces a brief inrush current of 0.100 Amps with filtered DC input (0.140 Amps with full-wave-rectified (VRMS) input) with a time duration of 100 milliseconds.
4. The Code 3 temporal pattern (1/2 second on, 1/2 second off, 1/2 second on, 1/2 second off, 1/2 second on, 1-1/2 off and repeat) is specified by ANSI and NFPA 72 for standard emergency evacuation signaling.

Note: When calculating the total currents for two wire chime strobe mode, use Table 2 to determine the highest value of RMS current for an individual strobe and add in the chime current from Table 1, multiply this value by total device current for a given NAC. Be sure to add the currents for any other appliances, including audible signaling appliances powered by the same source, and to include any required safety factors. In four wire mode, the total current draw for the strobe circuit and for the chime circuit must be calculated separately.

These appliances were tested to the voltage limits of 16.0-33.0 volts for 24V models using filtered DC or unfiltered Full-Wave-Rectified Voltage. Do not apply voltage outside of this range.

⚠ CAUTION: Strobes are not designed to be used on coded systems in which the applied voltage is cycled on and off.

⚠ WARNING: MAKE SURE THAT THE TOTAL RMS CURRENT REQUIRED BY ALL APPLIANCES THAT ARE CONNECTED TO THE SYSTEM'S PRIMARY AND SECONDARY POWER SOURCES DO NOT EXCEED THE POWER SOURCES' RATED CAPACITY OR THE CURRENT RATINGS OF ANY FUSES ON THE CIRCUITS TO WHICH THESE APPLIANCES ARE WIRED. OVERLOADING POWER SOURCES OR EXCEEDING FUSE RATINGS COULD RESULT IN LOSS OF POWER AND FAILURE TO ALERT OCCUPANTS DURING AN EMERGENCY, WHICH COULD RESULT IN PROPERTY DAMAGE AND SERIOUS INJURY OR DEATH TO YOU AND/OR OTHERS:

Table 3: Chime Tone Settings SW1		
Dip Position		MODE
1	2	
OFF	OFF	2Hz
OFF	ON	CODE 3 (T3)
ON	OFF	1Hz
ON	ON	CODED

⚠ CAUTION: Strobes are not designed to be used on coded systems in which the applied voltage is cycled on and off.

NOTE: In order to synchronize the Chime tone, the Chime device must **NOT** be set for coded operation

NOTE: Refer to instruction sheets for DSM (P83177) or Cooper Notification power supplies (P84905-002A) for additional information when synchronization is desired.

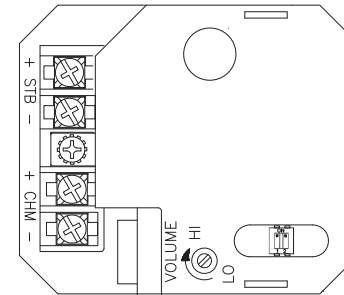

Figure 1:

The chime is factory set in code 3 (T3) mode. It can be changed before wiring the appliance with the dip switch. Refer to PC Board layout shown in Figure 1.

CODED OPERATION: The minimum input pulse duration must be at least 160 milliseconds "on" time and 160 milliseconds "off" time. The chime will only operate once each time it is pulsed. This mode is recommended for coded systems.

CODE 3, 1HZ, AND 2HZ: Continuous input voltage must be applied to the chime to activate the chime in these modes

The volume has been adjusted at the factory to insure maximum dBA output. However, once the mode is selected, the installer may want to fine tune the appliance to better suit the application. In a synchronized tone application, the Chime will default to temporal code 3 no matter what the DIP switches are set to (cannot be set to coded).

WIRING AND MOUNTING INFORMATION:

The following figures show the maximum number of field wires (conductors) that can enter the backbox used with each mounting option. If these limits are exceeded, there may be insufficient space in the backbox to accommodate the field wires and stresses from the wires could damage the product.

Check that the installed product will have sufficient clearance and wiring room prior to installing backboxes and conduit, especially if sheathed multiconductor cable or 3/4" conduit fittings are used.

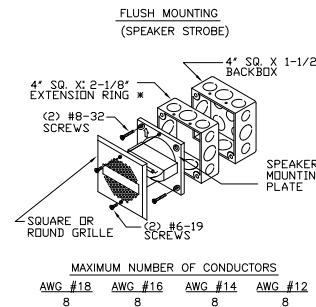

Figure A:

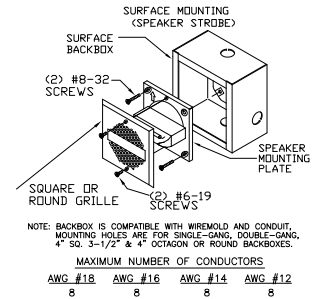

Figure B:

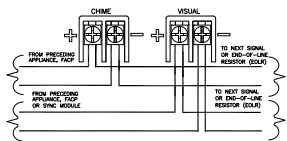

Figure 2:

Chime Appliance and Strobe Appliance operate independently. Recommended for coded systems where the chime is set on coded mode and is cycled on and off while the strobe flashes continuously

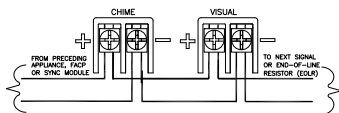
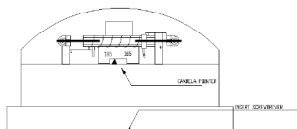

Figure 3:

Chime Appliance and Strobe Appliance operate in unison. Red and black wires are supplied. The chime must be set for any other mode than coded.



CANDELA SETTING

Figure 5:

NOTE: The CH70-24MCWH comes pre-set at 135cd

WARNING: THE CANDELA SELECT SWITCH MUST BE FIELD SET TO THE REQUIRED CANDELA INTENSITY BEFORE INSTALLATION. WHEN CHANGING THE SETTING OF THE CANDELA SELECT SWITCH, MAKE CERTAIN THAT IT "CLICKS" IN PLACE. AFTER CHANGING THE CANDELA SETTING, THE APPLIANCE MUST BE RETESTED TO VERIFY PROPER OPERATION.

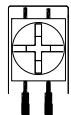

Figure 4

- The Chime Strobe model has in-out wiring terminals that accept two #12 to #18 American Wire Gauge (AWG) wires at each screw terminal. Strip leads 3/8 inches and connect to screw terminals.
- Break all in-out wire runs on supervised circuits to assure integrity of circuit supervision as shown in Figure
- The polarity shown in the wiring diagrams is for operation of the appliances. The polarity is reversed by the FACP during supervision

NOTE: In order to synchronize the Chime tone, the Chime device must not be set for coded operation (see page 3).

1. The chime must be set at maximum volume for Private Mode Fire Protective Service per UL 464 listing requirements (see page 2).
2. The chime produces a brief inrush current of 0.100 Amps with filtered DC input (0.140 Amps with full-wave-rectified (VRMS) input) with a time duration of 100 milliseconds.

NOTE: These notification appliances are UL Listed as "Special Application". They are intended to be used only with Cooper Notification appliance

NOTE: Refer to the installation instructions for the appropriate NAC to find the maximum allowed voltage drop. Use this value along with the current draw for the appliance to determine the allowable wire resistance.

MOUNTING PROCEDURES:

1. This model can be flush mounted to a 4" square by 2-1/8" deep backbox with a 4" square 1-1/2" extension ring surface mounted to a Surface Backbox Mounting hardware for each mounting option is supplied.
2. Conduit entrances to the backbox should be selected to provide sufficient wiring clearance for the installed product. Do not pass additional wires (used for other than the signaling appliance) through the backbox. Such additional wires could result in insufficient wiring space for the signaling appliance.
3. When terminating field wires, do not use more lead length than required. Excess lead length could result in insufficient wiring space for the signaling appliance.
4. Use care and proper techniques to position the field wires in the backbox so that they use minimum space and produce minimum stress on the product. This is especially important for stiff, heavy gauge wires and wires with thick insulation or sheathing.
5. This model has an integrated mounting plate which must be oriented correctly when it is mounted to the backbox. Turn the mounting plate so that the arrow above the words "Horizontal Strobe" or "Top" points to the top side of the mounting plate
6. To move selector switch, insert screwdriver into slot shown on the bottom side of the strobe. See Figure 5.
7. Mount the chime mounting plate to the backbox with the cone protector on. After the chime mounting plate is attached to the backbox, remove the cone protector before installing the grille. Next, attach the grille to the chime mounting plate and attach with (2) screws.

WARNING: INSTALLATION OF 110 OR HIGHER CANDELA STROBE PRODUCTS IN SLEEPING AREAS SHOULD BE WALL MOUNTED AT LEAST 24" BELOW THE CEILING AS FOLLOWS: (1) THE ON-AXIS (DIRECTLY IN FRONT OF LENS) LIGHT OUTPUT SHOULD BE DIRECTED AT THE EYELIDS OF THE SLEEPING PERSON, E.G. PILLOW END OF BED, BED HEAD; (2) NO PART OF THE BED SHALL BE MORE THAN SIXTEEN (16) FEET FROM THE STROBE NOTIFICATION APPLIANCE. INSTALLERS MUST ADVISE OWNERS AND OPERATORS OF BUILDINGS WITH SLEEPING OCCUPANTS, E.G. HOTELS AND MOTELS, TO WARN GUESTS, RESIDENTS AND EMPLOYEES TO NOT MOVE THE BED LOCATION TO A POSITION VIOLATING POINTS (1) AND (2) ABOVE OR SERIOUS INJURY AND/OR LOSS OF LIFE MAY OCCUR DURING A FIRE EMERGENCY.

WARNING: A SMALL POSSIBILITY EXISTS THAT THE USE OF MULTIPLE STROBES WITHIN A PERSON'S FIELD OF VIEW, UNDER CERTAIN CIRCUMSTANCES, MIGHT INDUCE A PHOTO-SENSITIVE RESPONSE IN PERSONS WITH EPILEPSY. STROBE REFLECTIONS IN A GLASS OR MIRRORED SURFACE MIGHT ALSO INDUCE SUCH A RESPONSE. TO MINIMIZE THIS POSSIBLE HAZARD, COOPER NOTIFICATION STRONGLY RECOMMENDS THAT THE STROBES INSTALLED SHOULD NOT PRESENT A COMPOSITE FLASH RATE IN THE FIELD OF VIEW WHICH EXCEEDS FIVE (5) Hz AT THE OPERATING VOLTAGE OF THE STROBES. COOPER NOTIFICATION ALSO STRONGLY RECOMMENDS THAT THE INTENSITY AND COMPOSITE FLASH RATE OF INSTALLED STROBES COMPLY WITH LEVELS ESTABLISHED BY APPLICABLE LAWS, STANDARDS, REGULATIONS, CODES AND GUIDELINES.

This equipment has been tested and found to comply with the limits for a Class A digital device, pursuant to part 15 of the FCC Rules. These limits are designed to provide reasonable protection against harmful interference when the equipment is operated in a commercial environment. This equipment generates, uses, and can radiate radio frequency energy and, if not installed and used in accordance with the instruction manual, may cause harmful interference to radio communications. Operation of this equipment in a residential area is likely to cause harmful interference in which case the user will be required to correct the interference at his own expense.

This Class A digital apparatus meets all requirements of the Canadian Interference-Causing Equipment Regulations. Cet appareil numérique de la classe A respecte toutes les exigences du Règlement sur le matériel brouilleur du Canada.

ANY MATERIAL EXTRAPOLATED FROM THIS DOCUMENT OR FROM COOPER WHEELLOCK MANUALS OR OTHER DOCUMENTS DESCRIBING THE PRODUCT FOR USE IN PROMOTIONAL OR ADVERTISING CLAIMS, OR FOR ANY OTHER USE, INCLUDING DESCRIPTION OF THE PRODUCT'S APPLICATION, OPERATION, INSTALLATION AND TESTING IS USED AT THE SOLE RISK OF THE USER AND COOPER WHEELLOCK WILL NOT HAVE ANY LIABILITY FOR SUCH USE.

Copyright 2018 Cooper Wheelock Inc., dba Cooper Notification. All rights reserved.

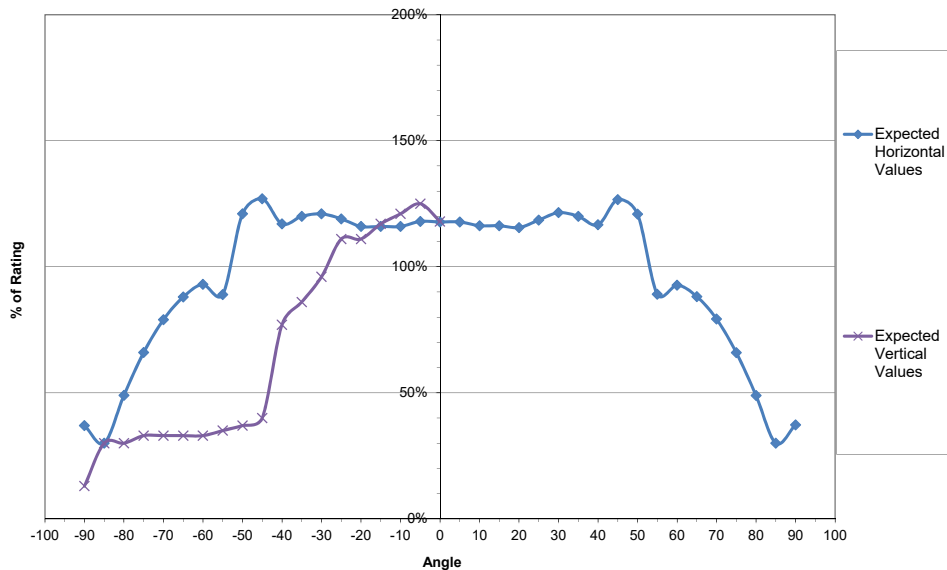

Figure 6:
Expected Light Output