



Thank you for using our products.
INSTALLATION INSTRUCTIONS
SERIES RSS AND RSSP STROBE APPLIANCES
(WALL MOUNT VERSIONS)

Use this product according to this instruction manual. Please keep this instruction manual for future reference.

GENERAL:

Cooper Notification's Series RSS and RSSP Strobes can provide a non-synchronized strobe appliance when connected directly to a Fire Alarm Control Panel (FACP), or provide a synchronized strobe appliance when used in conjunction with a Sync Module (SM), Dual Sync Module (DSM) or Cooper Notification's Power Supplies. The Series RSS and RSSP Strobe Appliances are UL Listed under Standard 1971 (Signaling Devices for the Hearing Impaired) for indoor fire protection service. The 1575W candela wall mounted strobes are listed at 15 candela under UL Standard 1971 and meet 75 candela intensity on axis with low current draw. These Strobes are listed for wall mount and indoor use only, with the backboxes specified in these instructions (See Mounting Options). RSS models have an integrated Strobe Mounting Plate (SMP) that can be mounted to a single-gang, double-gang, 4" backbox, 100mm European backbox or SHBB surface backbox. The strobes use a xenon flashtube with solid state circuitry enclosed in a polycarbonate lens to provide maximum visibility and reliability for effective visible signaling. All inputs are polarized for compatibility with standard reverse polarity supervision of circuit wiring by the Fire Alarm Control Panel (FACP).

NOTE: All CAUTIONS and WARNINGS are identified by the symbol . All warnings are printed in bold capital letters.

 WARNING: PLEASE READ THESE INSTRUCTIONS CAREFULLY BEFORE USING THIS PRODUCT. FAILURE TO COMPLY WITH ANY OF THE FOLLOWING INSTRUCTIONS, CAUTIONS AND WARNINGS COULD RESULT IN IMPROPER APPLICATION, INSTALLATION AND/OR OPERATION OF THESE PRODUCTS IN AN EMERGENCY SITUATION, WHICH COULD RESULT IN PROPERTY DAMAGE AND SERIOUS INJURY OR DEATH TO YOU AND/OR OTHERS.

SPECIFICATIONS:

<i>Table 1: Ratings Per UL</i>				
Model	Regulated Voltage (VDC/VRMS)	Voltage Range Limit Per UL 1971 (VDC/VRMS)	Strobe Candela (cd)	Mounting Options
RSS-241575W	24	16.0-33.0	15	A,B,C,D
RSSP-241575W	24	16.0-33.0	15	E,F
RSS-121575W	12	8.0-17.5	15	A,B,C,D
RSSP-121575W	12	8.0-17.5	15	E,F

All 1575 models are UL Listed at 15cd and meet 75cd on axis.

<i>Table 2: Audible/Speakers for RSSP Strobe/Plate</i>	
Product	Series
Multitone Appliances	AMT, MT, MT4
Motor Bells	MB-G6/G10
Speakers	ET-1010/1080, ET70, E70
Chimes	CH70

NOTES:

1. Strobes will produce 1 flash per second over the "Regulated Voltage" range.
2. These strobes meet the required light distribution patterns defined in UL 1971.
3. All models are listed by UL for indoor use with a temperature range of +32°F to +120°F (0°C to +49°C) and maximum humidity of 93% ± 2% RH. The effect of shipping and storage temperatures shall not adversely affect the performance of the appliance when it is stored in the original cartons and is not subjected to misuse or abuse.

<i>Table 3A: Current Ratings (AMPS) for 24VDC Models</i>		
Maximum RMS Current		
Voltage		241575W
DC	16.0-33.0VDC	0.090
FWR	16.0-33.0VRMS	0.145

<i>Table 3B: Current Ratings (AMPS) for 12VDC Models</i>		
Maximum RMS Current		
Voltage		121575W
DC	8.0-17.5VDC	0.255
FWR	8.0-17.5VRMS	0.335

When calculating the total currents use Table 3A and 3B to determine the highest value of RMS current for an individual strobe, then multiply these values by the total number of strobes. Be sure to add the currents for any other appliances, including audible signaling appliances powered by the same source, and to include any required safety factors.

NOTE: The maximum number of strobes on a single notification appliance circuit shall not exceed 50.

 CAUTION: These notification appliances are UL Listed as "Regulated". They are intended to be used with FACP's whose notification circuits are UL Listed as "Regulated." These appliances shall not be used on UL Listed "Special Application" notification circuits unless the appliances are identified to be compatible in the installation instructions of the FACP or unless the FACP is identified to be compatible in this instruction manual.

 WARNING: THESE APPLIANCES WERE TESTED TO THE REGULATED VOLTAGE LIMITS OF 16.0-33.0 VOLTS FOR 24V MODELS USING FILTERED DC OR UNFILTERED FULL-WAVE-RECTIFIED VOLTAGE. DO NOT APPLY VOLTAGE OUTSIDE OF THIS RANGE.

⚠ WARNING: CHECK THE MINIMUM AND MAXIMUM OUTPUT OF THE POWER SUPPLY AND STANDBY BATTERY AND SUBTRACT THE VOLTAGE DROP FROM THE CIRCUIT WIRING RESISTANCE TO DETERMINE THE APPLIED VOLTAGE TO THE STROBES. THE MAXIMUM WIRE IMPEDANCE BETWEEN STROBES SHALL NOT EXCEED 35 OHMS.

⚠ CAUTION: Strobes are not designed to be used on coded systems in which the applied voltage is cycled on and off.

⚠ WARNING: MAKE SURE THAT THE TOTAL RMS CURRENT REQUIRED BY ALL APPLIANCES THAT ARE CONNECTED TO THE SYSTEM'S PRIMARY AND SECONDARY POWER SOURCES, NOTIFICATION APPLIANCE CIRCUITS, SM, DSM SYNC MODULES, OR COOPER NOTIFICATION POWER SUPPLIES DOES NOT EXCEED THE POWER SOURCES' RATED CAPACITY OR THE CURRENT RATINGS OF ANY FUSES ON THE CIRCUITS TO WHICH THESE APPLIANCES ARE WIRED. OVERLOADING POWER SOURCES OR EXCEEDING FUSE RATINGS COULD RESULT IN LOSS OF POWER AND FAILURE TO ALERT OCCUPANTS DURING AN EMERGENCY, WHICH COULD RESULT IN PROPERTY DAMAGE AND SERIOUS INJURY OR DEATH TO YOU AND/OR OTHERS.

WIRING AND MOUNTING INFORMATION:

⚠ CAUTION: The following figures (A-F) show the maximum number of field wires (conductors) that can enter the backbox used with each mounting option. If these limits are exceeded, there may be insufficient space in the backbox to accommodate the field wires and stresses from the wires could damage the product.

⚠ CAUTION: Check that the installed product will have sufficient clearance and wiring room prior to installing backboxes and conduit, especially if sheathed multiconductor cable or 3/4" conduit fittings are used.

Although the limits shown for each mounting option comply with the National Electrical Code (NEC), Cooper Notification recommends use of the largest backbox option shown and the use of approved stranded field wires, whenever possible, to provide additional wiring room for easy installation and minimum stress on the product from wiring.

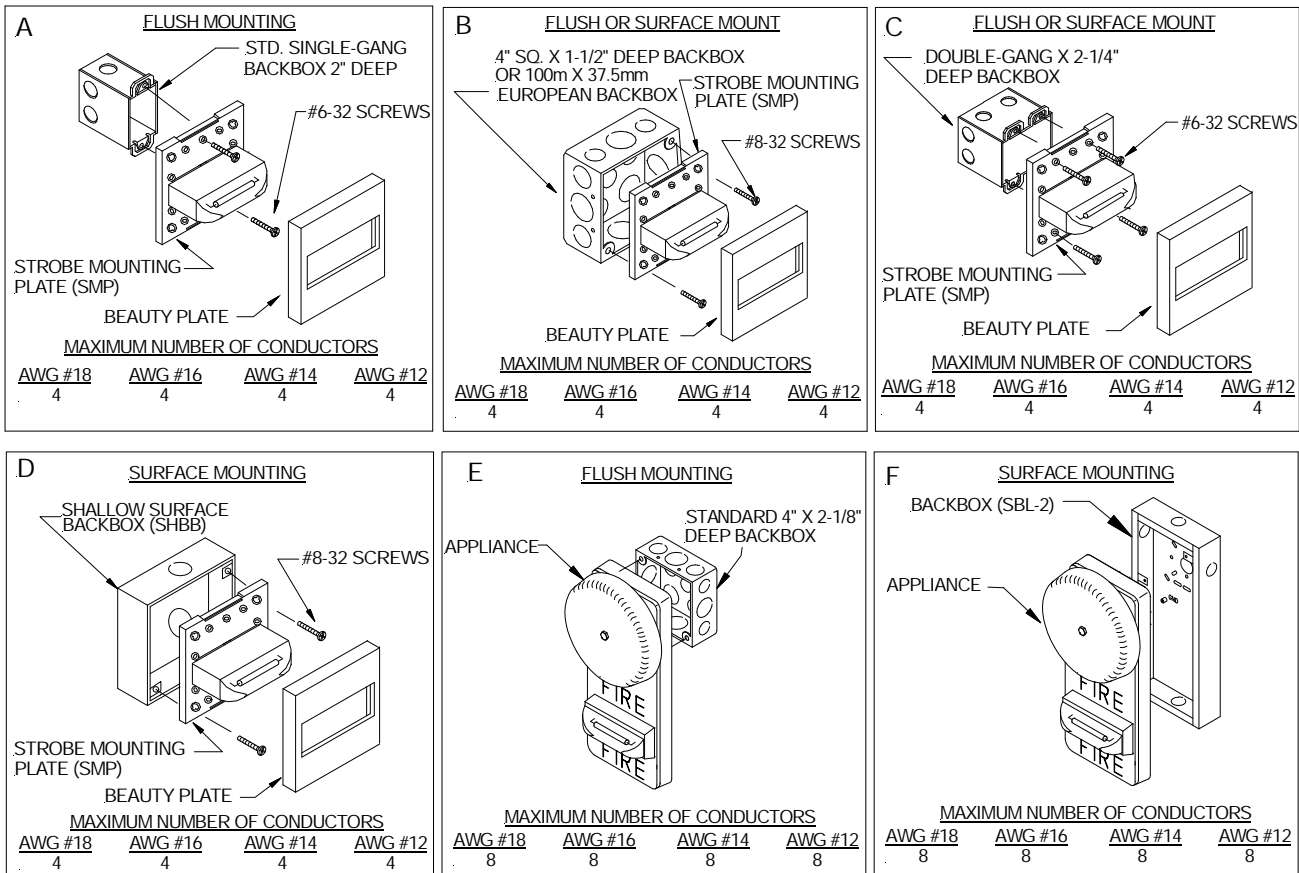

Figures E and F are shown with optional 6" bell. See Table 1A for other possible appliance combinations.

Figure 1: Wiring Diagrams

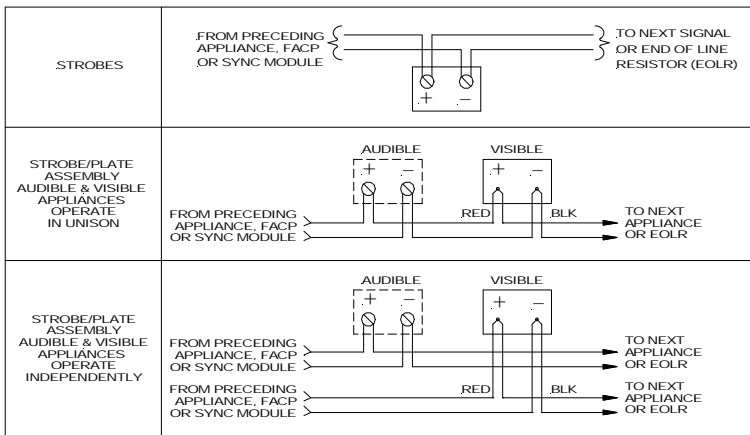
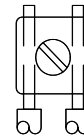

Figure 2:



1. All strobe appliances have in-out wiring terminals that accepts two #12 to #18 American Wire Gauge (AWG) wires at each screw terminal. Strip leads 3/8 inches and connect to screw terminals.
2. Break all in-out wire runs on supervised circuits to assure integrity of circuit supervision as shown in Figure 2. Strobe/Plate assembly has two red leads and two black leads for in-out wiring. The polarity shown in the wiring diagrams is for the operation of the appliances. The polarity is reversed by the FACP during supervision.

Refer to instruction sheets for SM (P83123), DSM (P83177) or Cooper Notification power supplies for additional information.

NOTE: Wiring method shall be in accordance with CSA C22.1, Canadian Electrical Code, Part 1, Safety Standard for Electrical Installations, Section 32.

1. This RSS model can be flush mounted to a standard single-gang backbox (Figure A), 4" or 100mm backbox (Figure B) or double-gang backbox (Figure C). It can also be surface mounted to a 4" or 100mm backbox (Figure B), double-gang backbox (Figure C) or the SHBB (Figure D). The RSSP model can be flush mounted to a 4" backbox (Figure E) or surface mounted to a SBL-2 backbox (Figure F). Mounting hardware for each mounting option is supplied.
2. Conduit entrances to the backbox should be selected to provide sufficient wiring clearance for the installed product. Do not pass additional wires (used for other than the signaling appliance) through the backbox. Such additional wires could result in insufficient wiring space for the signaling appliance.
3. When terminating field wires, do not use more lead length than required. Excess lead length could result in insufficient wiring space for the appliance.
4. Use care and proper techniques to position the field wires in the backbox so that they use minimum space and produce minimum stress on the product. This is especially important for stiff, heavy gauge wires and wires with thick insulation or sheathing.
5. This RSS model has an integrated Strobe Mounting Plate (SMP) which must be oriented correctly when it is mounted to the backbox. Turn the SMP so that the arrow above the words "Horizontal Strobe" points to the top side.
6. Mount the SMP first to the backbox. Next slide the beauty plate over the SMP until the 2 snaps of the beauty plate engage with the SMP.
7. The beauty plate can be removed from the strobe assembly once engaged. First, gently insert a screwdriver into one of the slots located on the top and bottom edges of the beauty plate. Second, gently pull away from the wall with the inserted screwdriver to disengage the snap. Third, repeat the first and second steps for the second slot. Finally, gently lift the beauty plate away from the SMP.

⚠ WARNING: REMOVAL OF THE BLACK COVER AT THE BACK OF THE MOUNTING PLATE COULD RESULT IN SEVERE ELECTRIC SHOCK.

⚠ WARNING: THE RSS STROBE APPLIANCE IS A "FIRE ALARM DEVICE - DO NOT PAINT."

⚠ WARNING: WHEN INSTALLING STROBES IN AN OPEN OFFICE OR OTHER AREAS CONTAINING PARTITIONS OR OTHER VIEWING OBSTRUCTIONS, SPECIAL ATTENTION SHOULD BE GIVEN TO THE LOCATION OF THE STROBES SO THAT THEIR OPERATING EFFECT CAN BE SEEN BY ALL INTENDED VIEWERS, WITH THE INTENSITY, NUMBER, AND TYPE OF STROBES BEING SUFFICIENT TO MAKE SURE THAT THE INTENDED VIEWER IS ALERTED BY PROPER ILLUMINATION, REGARDLESS OF THE VIEWER'S ORIENTATION. FAILURE TO DO SO COULD RESULT IN PROPERTY DAMAGE AND SERIOUS INJURY OR DEATH TO YOU AND/OR OTHERS.

⚠ WARNING: A SMALL POSSIBILITY EXISTS THAT THE USE OF MULTIPLE STROBES WITHIN A PERSON'S FIELD OF VIEW, UNDER CERTAIN CIRCUMSTANCES, MIGHT INDUCE A PHOTO-SENSITIVE RESPONSE IN PERSONS WITH EPILEPSY. STROBE REFLECTIONS IN A GLASS OR MIRRORRED SURFACE MIGHT ALSO INDUCE SUCH A RESPONSE. TO MINIMIZE THIS POSSIBLE HAZARD, COOPER NOTIFICATION STRONGLY RECOMMENDS THAT THE STROBES INSTALLED SHOULD NOT PRESENT A COMPOSITE FLASH RATE IN THE FIELD OF VIEW WHICH EXCEEDS FIVE (5) Hz AT THE OPERATING VOLTAGE OF THE STROBES. COOPER NOTIFICATION ALSO STRONGLY RECOMMENDS THAT THE INTENSITY AND COMPOSITE FLASH RATE OF INSTALLED STROBES COMPLY WITH LEVELS ESTABLISHED BY APPLICABLE LAWS, STANDARDS, REGULATIONS, CODES AND GUIDELINES.

NOTE: NFPA 72/ANSI 117.1 conform to ADAAG Equivalent Facilitation Guidelines in using fewer, higher intensity strobes within the same protected area.

⚠ CAUTION: Check the installation instructions of the manufacturers of other equipment used in the system for any guidelines or restrictions on wiring and/or locating Notification Appliance Circuits (NAC) and notification appliances. Some system communication circuits and/or audio circuits, for example, may require special precautions to assure immunity electrical noise (e.g. audio crosstalk).

ANY MATERIAL EXTRAPOLATED FROM THIS DOCUMENT OR FROM COOPER NOTIFICATION MANUALS OR OTHER DOCUMENTS DESCRIBING THE PRODUCT FOR USE IN PROMOTIONAL OR ADVERTISING CLAIMS, OR FOR ANY OTHER USE, INCLUDING DESCRIPTION OF THE PRODUCT'S APPLICATION, OPERATION, INSTALLATION AND TESTING IS USED AT THE SOLE RISK OF THE USER AND COOPER NOTIFICATION WILL NOT HAVE ANY LIABILITY FOR SUCH USE.

NOTE: This equipment has been tested and found to comply with the limits for a Class B digital device, pursuant to Part 15 of the FCC Rules. These limits are designed to provide reasonable protection against harmful interference in residential installation. This equipment generates, uses and can radiate radio frequency energy and, if not installed and used in accordance with the instructions, may cause harmful interference to radio communications. However, there is no guarantee that interference will not occur in a particular installation. If this equipment does cause harmful interference to radio or television reception, which can be determined by turning the equipment off and on, the user is encouraged to try to correct the interference by one or more of the following measures: 1) Reorient or relocate the receiving antenna, 2) Increase the separation between the equipment and receiver, 3) Connect the equipment into an outlet on a circuit different from that to which the receiver is connected, and 4) Consult the dealer or an experienced radio/TV technician for help.

LIMITED WARRANTY

Cooper Wheelock, Inc. dba Cooper Notification and Cooper Notification, Inc. (each, a "Seller") products must be used within their published specifications and must be PROPERLY specified, applied, installed, operated, maintained and operationally tested in accordance with these instructions at the time of installation and at least twice a year or more often and in accordance with local, state and federal codes, regulations and laws. Specification, application, installation, operation, maintenance and testing must be performed by qualified personnel for proper operation in accordance with all of the latest National Fire Protection Association (NFPA), Underwriter's Laboratories (UL), National Electrical Code (NEC), Occupational Safety and Health Administration (OSHA), local, state, county, province, district, federal and other applicable building and fire standards, guidelines, regulations laws and codes including, but not limited to, all appendices and amendments and the requirements of the local authority having jurisdiction (AHJ). Seller products when properly specified, applied, installed, operated, maintained and operationally tested as provided above are warranted against mechanical and electrical defects for a period of (a) three (3) years from date of manufacture with respect to MEDC and Seller Industrial Signals and Seller Fire and Security Notification Appliances and Devices, or (b) one (1) year from date of manufacture with respect to Waves and SafePath Voice Evacuation and Mass Notification Systems (date of manufacture is determined by date code.) Correction of defects by repair or replacement shall be at Seller's sole discretion and shall constitute fulfillment of all obligations under this warranty. THE FOREGOING LIMITED WARRANTY SHALL IMMEDIATELY TERMINATE IN THE EVENT ANY PART NOT FURNISHED BY SELLER IS INSTALLED IN THE PRODUCT. THE FOREGOING LIMITED WARRANTY SPECIFICALLY EXCLUDES ANY SOFTWARE REQUIRED FOR THE OPERATION OF OR INCLUDED IN A PRODUCT. SELLER MAKES NO REPRESENTATION OR WARRANTY OF ANY OTHER KIND, EXPRESS, IMPLIED OR STATUTORY WHETHER AS TO MECHANICALITY, FITNESS FOR A PARTICULAR PURPOSE OR ANY OTHER MATTER.

USERS ARE SOLELY RESPONSIBLE FOR DETERMINING WHETHER A PRODUCT IS SUITABLE FOR THE USER'S PURPOSES, OR WHETHER IT WILL ACHIEVE THE USER'S INTENDED RESULTS. THERE IS NO WARRANTY AGAINST DAMAGE RESULTING FROM MISAPPLICATION, IMPROPER SPECIFICATION, ABUSE, ACCIDENT OR OTHER OPERATING CONDITIONS BEYOND SELLER'S CONTROL.

SELLER DOES NOT WARRANT THAT THE OPERATION OF THE SOFTWARE WILL BE UNINTERRUPTED OR ERROR-FREE OR THAT THE SOFTWARE WILL MEET ANY OTHER STANDARD OF PERFORMANCE, OR THAT THE FUNCTIONS OR PERFORMANCE OF THE SOFTWARE WILL MEET THE USER'S REQUIREMENTS. SELLER SHALL NOT BE LIABLE FOR ANY DELAYS, BREAKDOWNS, INTERRUPTIONS, LOSS, DESTRUCTION, ALTERATION, OR OTHER PROBLEMS IN THE USE OF A PRODUCT ARISING OUT OF OR CAUSED BY THE SOFTWARE.

THE LIABILITY OF SELLER ARISING OUT OF THE SUPPLYING OF A PRODUCT, OR ITS USE, WHETHER ON WARRANTIES, NEGLIGENCE, OR OTHERWISE, SHALL NOT IN ANY CASE EXCEED THE COST OF CORRECTING DEFECTS AS STATED IN THE LIMITED WARRANTY AND UPON EXPIRATION OF THE WARRANTY PERIOD ALL SUCH LIABILITY SHALL TERMINATE. SELLER IS NOT LIABLE FOR LABOR COSTS INCURRED IN REMOVAL, REINSTALLATION OR REPAIR OF A PRODUCT BY ANYONE OTHER THAN SELLER OR FOR DAMAGE OF ANY TYPE WHATSOEVER, INCLUDING BUT NOT LIMITED TO, LOSS OF PROFIT OR INCIDENTAL, INDIRECT, CONSEQUENTIAL, SPECIAL, PUNITIVE OR EXEMPLARY DAMAGES. THE FOREGOING SHALL CONSTITUTE THE SOLE REMEDY OF THE PURCHASER AND THE EXCLUSIVE LIABILITY OF SELLER.

IN NO CASE WILL SELLER'S LIABILITY EXCEED THE PURCHASE PRICE PAID FOR A PRODUCT.

LIMITATION OF LIABILITY

SELLER'S LIABILITY ON ANY CLAIM OF ANY KIND, INCLUDING NEGLIGENCE AND BREACH OF WARRANTY, FOR ANY LOSS OR DAMAGE RESULTING FROM, ARISING OUT OF, OR CONNECTED WITH THIS CONTRACT, OR FROM THE MANUFACTURE, SALE, DELIVERY, RESALE, REPAIR OR USE OF ANY PRODUCT COVERED BY THIS ORDER SHALL BE LIMITED TO THE PRICE APPLICABLE TO THE PRODUCT OR PART THEREOF WHICH GIVES RISE TO THE CLAIM. SELLER'S LIABILITY ON ANY CLAIM OF ANY KIND SHALL CEASE IMMEDIATELY UPON THE INSTALLATION IN THE PRODUCT OF ANY PART NOT FURNISHED BY SELLER. IN NO EVENT SHALL SELLER BE LIABLE FOR ANY CLAIM OF ANY KIND UNLESS IT IS PROVEN THAT ITS PRODUCT WAS THE DIRECT CAUSE OF SUCH CLAIM. FURTHER, IN NO EVENT, INCLUDING IN THE CASE OF A CLAIM OF NEGLIGENCE, SHALL SELLER BE LIABLE FOR INCIDENTAL, INDIRECT, CONSEQUENTIAL, SPECIAL, PUNITIVE OR EXEMPLARY DAMAGES. SOME STATES DO NOT ALLOW THE EXCLUSION OR LIMITATION OF INCIDENTAL OR CONSEQUENTIAL DAMAGES, SO THE PRECEDING LIMITATION MAY NOT APPLY TO ALL PURCHASERS.