

Possibilities of Light

Direct Ambient  
Lighting

**Luminous HE 282/284**



**Open Office Application**

**Fixture Type:** 284R-2T5  
**Fixture Qty:** 42  
**Room Size:** 60' x 60' x 9'  
**Fixture Spacing:** 8' x 10'  
**Light Level:** 42fc\*  
**Power Density:** .62 W/ft<sup>2</sup>  
**Fixture Efficiency:** 94%  
**Fixture Wattage:** 53W

*\*(Avg. maintained,  
Ballast Factor .85, LLF = .80)*

**Luminous HE: A High Efficiency volumetric recessed ambient luminaire with**

### Class Room Application

Fixture Type: 282R-2T5HO  
Fixture Qty: 15

Room Size: 32' x 32' x 12'

Fixture Spacing: 8' x 8'

Light Level: 37fc\*

Power Density: .76 W/ft<sup>2</sup>

Fixture Efficiency: 91%

Fixture Wattage: 52W

\*(Avg. maintained,  
Ballast Factor 1.0, LLF = .80)

**bold regressed acrylic diffusers providing a refreshing architectural detail**

PHOTOMETRICS

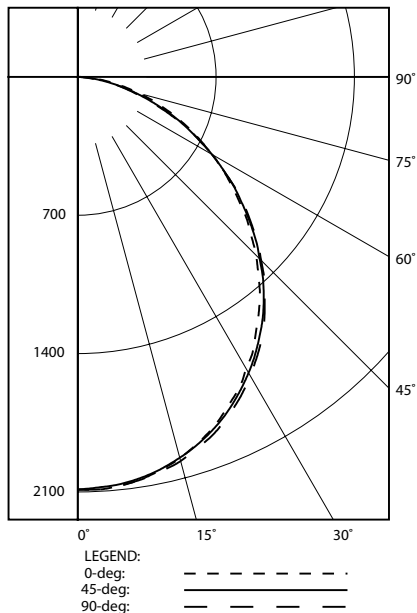

COEFFICIENTS OF UTILIZATION - ZONAL CAVITY METHOD  
 EFFECTIVE FLOOR CAVITY REFLECTANCE 0.20

RC	80				70				50			30			10			0	
	RW	70	50	30	10	70	50	30	10	50	30	10	50	30	10	50	30	10	0
0		112	112	112	112	110	110	110	110	105	105	105	100	100	100	96	96	96	94
1		103	99	95	91	100	97	93	90	93	90	87	89	87	84	86	84	82	80
2		94	86	80	75	92	85	79	74	81	77	72	78	74	71	75	72	69	67
3		86	76	69	63	84	75	68	62	72	66	61	69	64	60	67	63	59	57
4		79	68	60	54	77	67	59	53	64	58	52	62	56	52	60	55	51	49
5		73	61	52	46	71	60	52	46	58	51	46	56	50	45	54	49	45	43
6		67	55	46	41	65	54	46	40	52	45	40	51	44	40	49	44	39	37
7		62	50	42	36	61	49	41	36	48	41	35	46	40	35	45	39	35	33
8		58	45	38	32	57	45	37	32	44	37	32	42	36	32	41	36	31	30
9		54	42	34	29	53	41	34	29	40	33	29	39	33	29	38	33	28	27
10		51	39	31	26	50	38	31	26	37	31	26	36	30	26	35	30	26	24

ZONAL LUMEN SUMMARY

ZONE	LUMENS	%LAMP	%FIXT
0- 30	1609	27.7	29.4
0- 40	2610	45.0	47.8
0- 60	4470	77.1	81.8
0- 90	5466	94.2	100.0
90-180	0	0.0	0.0
0-180	5466	94.2	100.0

**TOTAL LUMINAIRE EFFICIENCY = 94.2 %**

284R: 2'x4'; (2)28WT5; Acrylic Side Diffusers; High Transmission Center Diffuser

Catalog#: 284R-2T5-UEB-95HT  
 Report#: P30965

APPLICATION LAYOUTS

**Fixture Type:** 284R - 2T5  
**Fixture Qty:** 2  
**Room Size:** 10' x 12' x 9'  
**Fixture Spacing:** 4' O.C.  
**Light Level:** 41fc\*  
**Power Density:** .96 W/ft<sup>2</sup>  
**Fixture Efficiency:** 94%  
**Fixture Wattage:** 59W  
 \*(Avg.maintained,  
 Ballast Factor .90, LLF = .80)

Private Office

**Fixture Type:** 282R - 2T5  
**Fixture Qty:** 5  
**Room Size:** 8' x 50' x 9'  
**Fixture Spacing:** 10' O.C.  
**Light Level:** 15fc\*  
**Power Density:** .41 W/ft<sup>2</sup>  
**Fixture Efficiency:** 90%  
**Fixture Wattage:** 33W  
 \*(Avg.maintained,  
 Ballast Factor 1.0, LLF = .80)

Corridor

**Fixture Type:** 282R - 2T5HO  
**Fixture Qty:** 25  
**Room Size:** 40' x 46' x 10'  
**Fixture Spacing:** 8' x 8'  
**Light Level:** 45fc\*  
**Power Density:** .71W/ft<sup>2</sup>  
**Fixture Efficiency:** 91%  
**Fixture Wattage:** 52W  
 \*(Avg.maintained,  
 Ballast Factor 1.0, LLF = .80)

Retail Store

ORDERING INFORMATION

Sample Number: 282-R-2-T5-ESTG-UEB-SI-95N

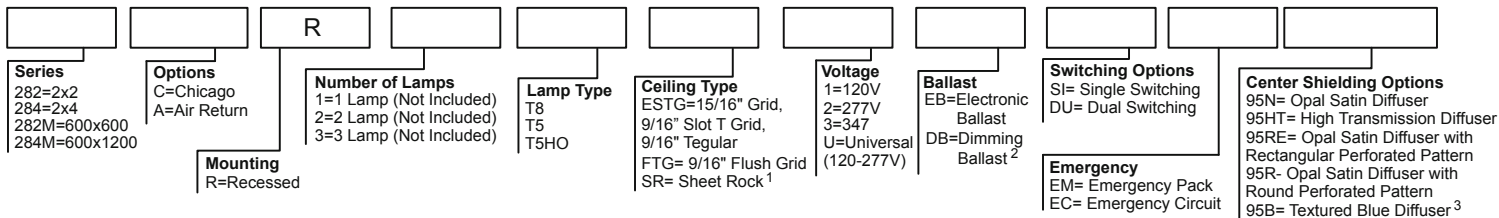

Notes

1. For Sheet Rock Specify Metalux DFW series drywall frame-in kit, ordered separately, from Metalux: For 2x2 order Metalux part# DF-22W-U, 2x4 part #DF-24W-U
2. For dimming specify ballast type
3. Consult factory for additional colors or textures

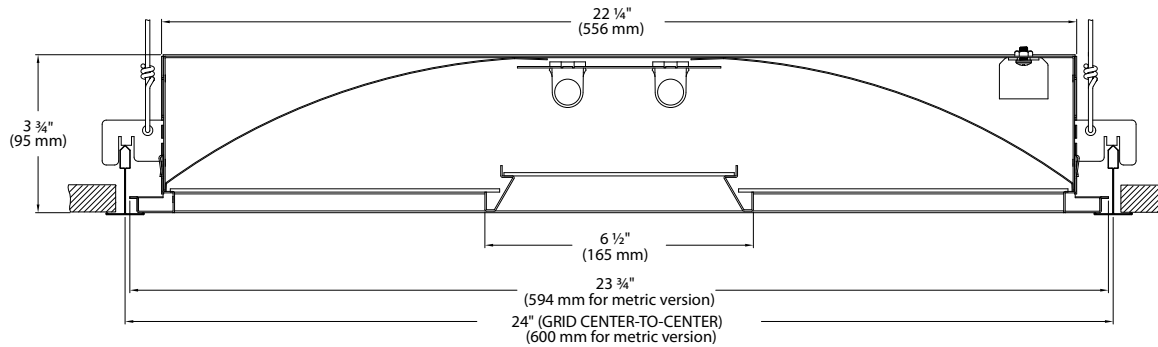
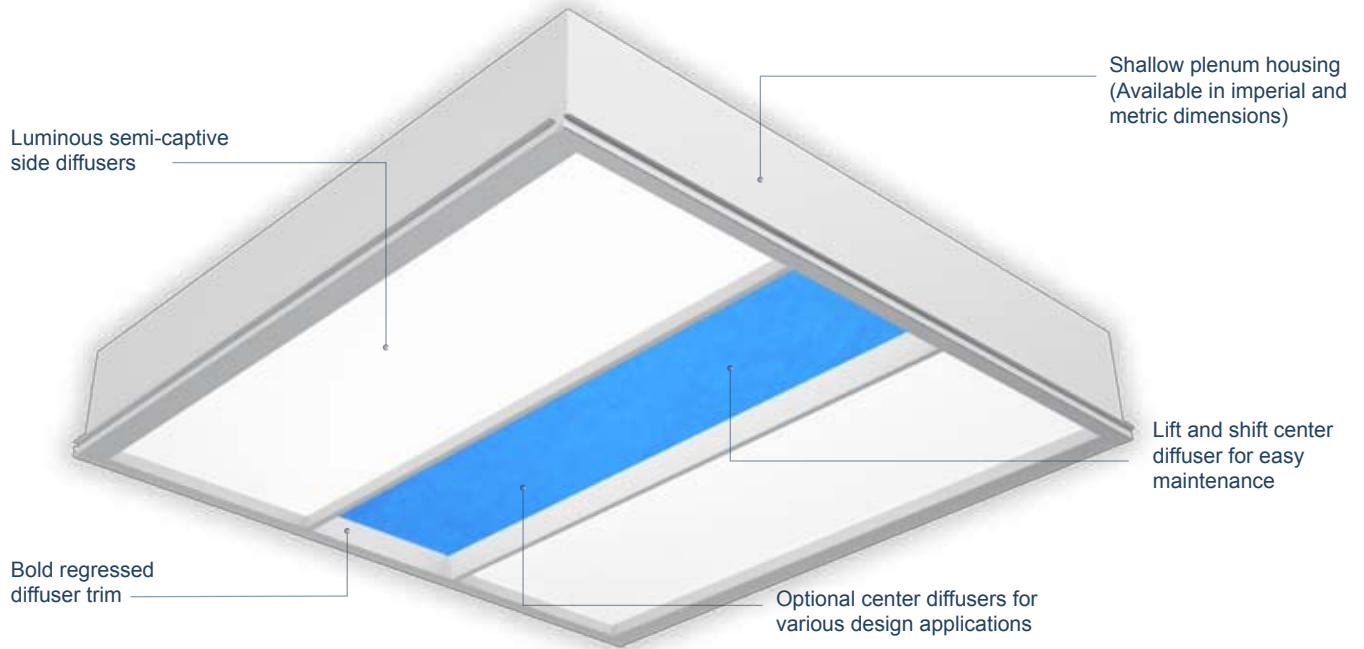

**MOUNTING OPTIONS**

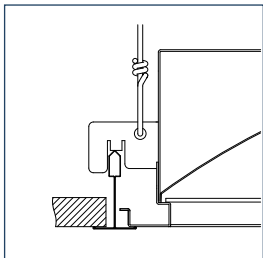

**ESTG = 15/16" Flush Tee Grid**

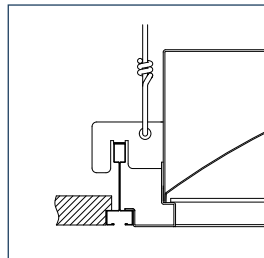

**ESTG = 9/16" Slot Tee Grid**

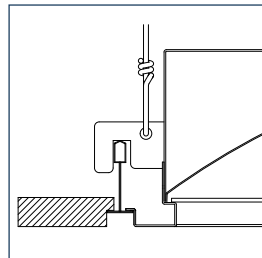

**ESTG = 9/16" Tegular Grid**

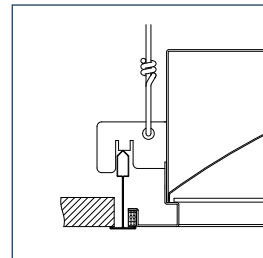

**FTG = 9/16" Flush Tee Grid**

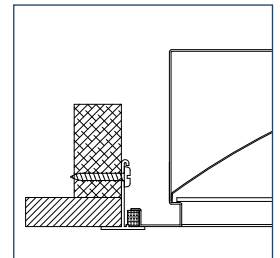

**SR = Sheet Rock**

**CENTER DIFFUSER OPTIONS**

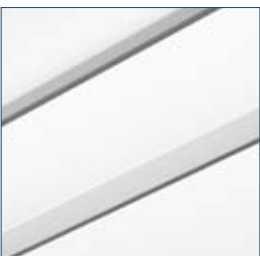

**95N**  
Opal Satin (74%) Diffuser



**95HT**  
High Transmission (87%) Diffuser

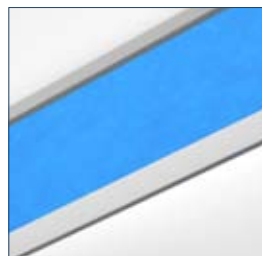

**95B**  
Textured Blue Diffuser



**95R**  
Opal Satin Diffuser with Round Perforated Pattern

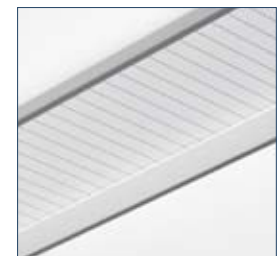

**95RE**  
Opal Satin Diffuser with Rectangular Perforated Pattern

**Cooper Lighting**

Customer First Center  
1121 Highway 74 South  
Peachtree City, GA 30269

P: 770-486-4800  
F: 770-486-4801  
[www.cooperlighting.com](http://www.cooperlighting.com)

**Neo-Ray**

100 Andrews Road  
Hicksville, NY 11801

P: 516-470-1000  
F: 516-470-1077

**International Sales, USA**

Cooper Lighting  
1121 Highway 74 South  
Peachtree City, GA 30269

P: 770-486-4800  
F: 770-486-4801

**Canada**

Cooper Lighting  
5925 McLaughlin Road  
Mississauga, Ontario L5R 1B8

P: 905-501-3000  
F: 905-501-3172

**The Cooper Lighting Family**

Halo  
Metalux  
Lumark  
Sure-Lites  
Neo-Ray  
AtLite  
Corelite  
Portfolio  
Iris  
Shaper  
io  
Lumière  
Invue  
McGraw-Edison  
Streetworks  
Fail-Safe  
PDS  
MWS  
RSA  
Ametrix

**Domestic Facilities**

Cranbury, New Jersey  
Hicksville, New York  
Elk Grove Village, Illinois  
Irving, Texas  
Ontario, California  
Peachtree City, Georgia

**Canadian Facilities**

Calgary, Alberta T2E 7V9  
Mississauga, Ontario L5R 1B8

**Cooper Industries, Ltd.**  
600 Travis, Ste. 5800  
Houston, TX 77002-1001  
P: 713-209-8400  
[www.cooperindustries.com](http://www.cooperindustries.com)