

## DESCRIPTION

The Prevail LED area, site luminaire combines optical performance, energy efficiency and long term reliability in an advanced, patent pending modern design. Utilizing the latest LED technology, the Prevail luminaire delivers unparalleled uniformity resulting in greater pole spacing. A versatile mount standard arm facilitates ease of installation for both retrofit and new installations. With energy savings greater than 62%, the Prevail fixture replaces 150-450W metal halide fixtures in general area lighting applications such as parking lots, walkways, roadways and building areas.

<b>Catalog #</b>		<b>Type</b>	
<b>Project</b>		<b>Date</b>	
<b>Comments</b>			
<b>Prepared by</b>			

## SPECIFICATION FEATURES

### Construction

Construction is comprised of a heavy-duty, single-piece die-cast aluminum housing. The LED drivers are mounted in direct contact with the casting to promote low operating temperature and long life. The die-cast aluminum door is tethered to provide easy access to the driver if replacement is required. A one-piece silicone gasket seals the door to the fixture housing. The optics is mounted on a versatile, aluminum plate that dissipates heat from the LEDs resulting in longer life of the fixture. The fixture is IP66 and 3G vibration rated (ANSI C136.31) to insure strength of construction and longevity in the selected application.

### Optics

Precision molded, high efficiency optics are precisely designed to shape the distribution, maximizing efficiency and application spacing. Available in Type II, III, IV and V distributions with lumen packages ranging from 6,100 to 18,900 nominal lumens. Light engine configurations consist of 1 or 2 high-efficacy LEDs mounted to metal-core circuit boards to maximize heat dissipation and promote long life (up to L92/60,000 hours at 25°C) per IESNA TM-21. For the ultimate level of spill light control, an optional house side shield accessory can be field or factory installed.

### Electrical

LED drivers are mounted to the fixture for optimal heat sinking and ease of maintenance. Thermal management incorporates both conduction and convection to transfer heat rapidly away from the LED source for optimal efficiency and light output. Class 1 electronic drivers have a power factor >90%, THD <20%, and an expected life of 100,000 hours with <1% failure rate. Available in 120-277V 50/60Hz, 347V 60Hz or 480V 60Hz operation. 480V is compatible for use with 480V Wye systems only. 10kV/10 kA surge protection standard. 0-10V dimming driver is standard with leads external to the fixture to accommodate controls capability such as dimming and occupancy. Suitable for ambient temperatures from -40°C to 40°C. Optional 50°C HA (high ambient) available. Standard NEMA 3-PIN twistlock photocontrol receptacle and NEMA 7-PIN twistlock photocontrol receptacles are available as options.

### Controls

The Prevail LED luminaire control options are designed to be simple and cost-effective ASHRAE and California Title 24 compliant solutions. The ANSI C136.41 compliant NEMA 7-PIN receptacle enables wireless dimming when used with compatible photocontrol. An integrated dimming and occupancy sensor is a standalone control option available in on/off (MSP) and bi-level dimming

(MSP/DIM) operation. The optional LumaWatt Pro system is best described as a peer-to-peer wireless network of luminaire-integral sensors that operate in accordance with programmable profiles. Each sensor is capable of motion and photo sensing, metering power consumption and wireless communication.

### Mounting

Standard pole mount arm is bolted directly to the pole and the fixture slides onto the arm and locks in place with a bolt facilitating quick and easy installation. The versatile, patented, standard mount arm accommodates multiple drill patterns ranging from 1-1/2" to 4-7/8". Removal of the door on the standard mounting arm enables wiring of the fixture without having to access the driver compartment. A knock-out on the standard mounting arm enables round pole mounting. Wall mount and mast arm mounting options are available. Mast arm adapter fits 2-3/8" O.D. tenon.

### Finish

Housing and cast parts finished in five-stage super TGIC polyester powder coat paint, 2.5 mil nominal thickness for superior protection against fade and wear. Standard color is bronze. Additional colors available in white, grey, black, dark platinum and graphite metallic.

### Warranty

Five-year warranty.



## PRV PREVAIL

LED

AREA / SITE / ROADWAY  
LUMINAIRE



### CERTIFICATION DATA

UL and cUL Wet Location Listed  
IP66-Rated  
3G Vibration Rated  
ISO 9001  
DesignLights Consortium® Qualified\*

### ENERGY DATA

**Electronic LED Driver**  
0.9 Power Factor  
<20% Total Harmonic Distortion  
120-277V/50 and 60Hz,  
347V/60Hz, 480V/60Hz  
-40°C Minimum Temperature Rating  
+40°C Ambient Temperature Rating

### EPA

Effective Projected Area (Sq. Ft.): 0.75

### SHIPPING DATA

Approximate Net Weight:  
20 lbs. (9.09 kgs.)

## DIMENSIONS

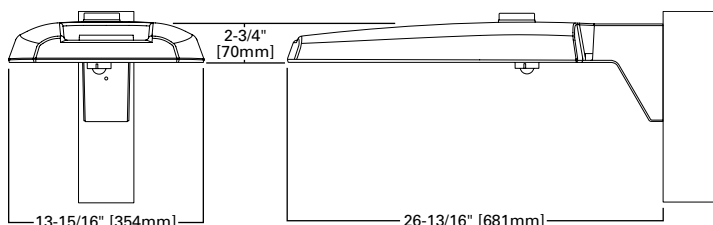

**VERSATILE MOUNT SYSTEM**

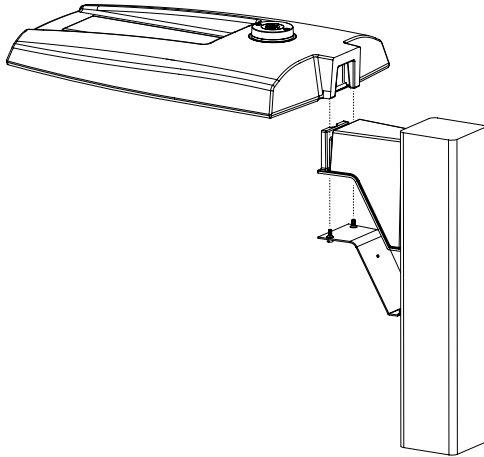

**POLE MOUNT ARM**

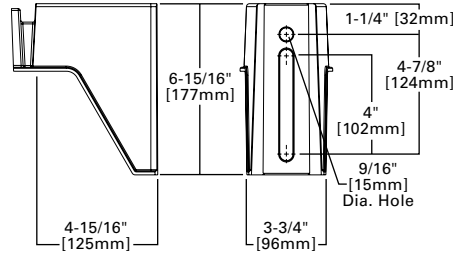

**WALL MOUNT**

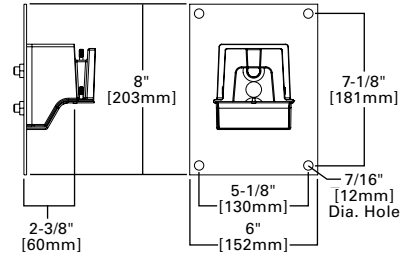

**MAST ARM MOUNT**

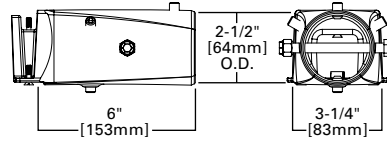

**MOUNTING CONFIGURATIONS AND EPAS**

**Wall Mount**

**Arm Mount Single**  
EPA 0.75

**Arm Mount 2 @ 180°**  
EPA 1.50

**Arm Mount 2 @ 90°**  
EPA 1.50

**Arm Mount 3 @ 90°**  
EPA 2.25

**Arm Mount 4 @ 90°**  
EPA 3.00

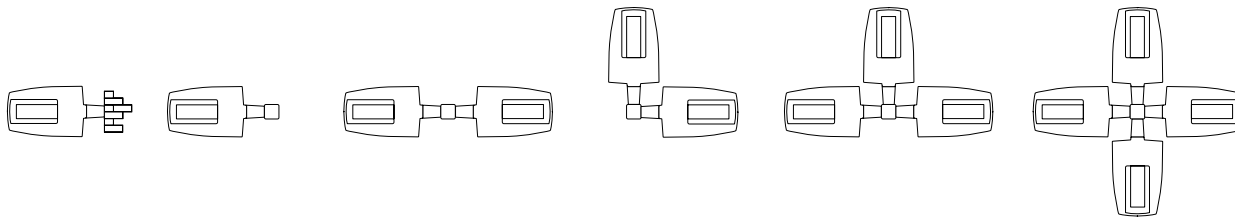

**OPTICAL CONFIGURATIONS**

**A15** (6,100 Nominal Lumens)

**A25/A40/A60** (10,200/15,100/18,900 Nominal Lumens)

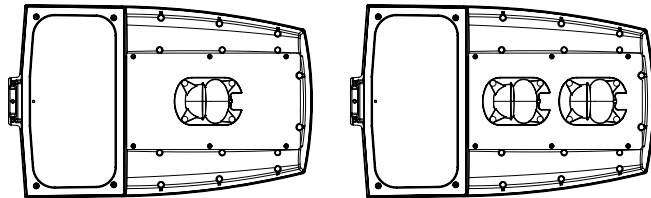

**POWER AND LUMENS**

Light Engine		A15	A25	A40	A60
Nominal Power (Watts)		57W	87W	143W	163W
Input Current @ 120V (A)		0.49	0.76	1.23	1.34
Input Current @ 277V (A)		0.22	0.35	0.54	0.60
Input Current @ 347V (A)		0.18	0.28	0.45	0.49
Input Current @ 480V (A)		0.13	0.21	0.33	0.35
Type II	Lumens	6,139	10,204	15,073	18,830
	BUG Rating	B1-U0-G1	B2-U0-G2	B3-U0-G3	B3-U0-G3
Type III	Lumens	6,192	10,292	15,203	18,992
	BUG Rating	B1-U0-G2	B2-U0-G3	B2-U0-G3	B3-U0-G4
Type IV	Lumens	6,173	10,261	15,157	18,935
	BUG Rating	B1-U0-G3	B2-U0-G3	B2-U0-G4	B2-U0-G5
Type V	Lumens	6,393	10,627	15,697	19,610
	BUG Rating	B3-U0-G3	B4-U0-G3	B4-U0-G4	B5-U0-G4

NOTE: Lumen output for standard bronze fixture color. Different housing colors impact lumen output. IES files for the non-standard colors are available upon request.

**LUMEN MAINTENANCE**

Ambient Temperature	25,000 Hours*	50,000 Hours*	60,000 Hours*	Theoretical 100,000 Hours	Theoretical L70 (Hours)*
25°C	> 96%	> 93%	> 92%	> 87%	> 260,000
40°C	> 96%	> 93%	> 92%	> 87%	> 255,000
50°C	> 95%	> 92%	> 91%	> 86%	> 250,000

\* Per IESNA TM-21 data.

**LUMEN MULTIPLIER**

Ambient Temperature	Lumen Multiplier
10°C	1.02
15°C	1.01
25°C	1.00
40°C	0.99

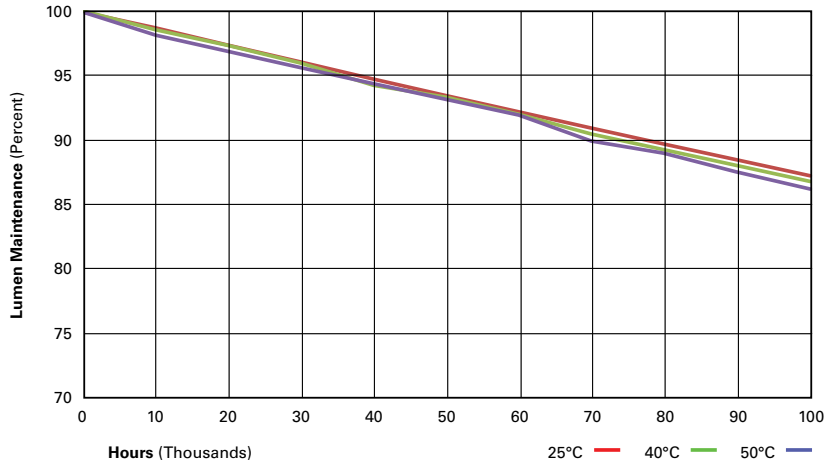

**ORDERING INFORMATION**

Sample Number: PRV-A25-D-UNV-T3-SA-BZ

Product Family <sup>1,2</sup>	Light Engine <sup>3</sup>	Driver <sup>4</sup>	Voltage	Distribution	Mounting	Color <sup>6</sup>
PRV=Prevail	A15=(1 LED) 6,100 Nominal Lumens A25=(2 LEDs) 10,200 Nominal Lumens A40=(2 LEDs) 15,100 Nominal Lumens A60=(2 LEDs) 18,900 Nominal Lumens	D=Dimming (0-10V)	UNV=Universal (120-277V) 347=347V 480=480V <sup>5</sup>	T2=Type II T3=Type III T4=Type IV T5=Type V	SA=Standard Versatile Arm MA=Mast Arm WM=Wall Mount Arm	AP=Grey BZ=Bronze (Standard) BK=Black DP=Dark Platinum GM=Graphite Metallic WH=White
<b>Options (Add as Suffix)</b>				<b>Accessories (Order Separately) <sup>12</sup></b>		
7030=70 CRI / 3000K CCT <sup>7</sup> 7050=70 CRI / 5000K CCT <sup>7</sup> 10K=10kV/10kA UL 1449 Fused Surge Protective Device LWR-LW=LumaWatt Pro Wireless Sensor, Wide Lens for 8' - 16' Mounting Height <sup>8,9,10</sup> LWR-LN=LumaWatt Pro Wireless Sensor, Narrow Lens for 16' - 40' Mounting Height <sup>8,9,10</sup> MSP/DIM-L12=Integrated Sensor for Dimming Operation, 8' - 12' Mounting Height MSP/DIM-L30=Integrated Sensor for Dimming Operation, 12' - 30' Mounting Height MSP-L12=Integrated Sensor for ON/OFF Operation, 8' - 12' Mounting Height MSP-L30=Integrated Sensor for ON/OFF Operation, 12' - 30' Mounting Height PER=NEMA 3-PIN Twistlock Photocontrol Receptacle <sup>11</sup> PER7=NEMA 7-PIN Twistlock Photocontrol Receptacle <sup>11</sup> HSS=House Side Shield HA=50°C High Ambient Temperature L90=Optics Rotated 90° Left R90=Optics Rotated 90° Right				PRVWM-XX=Wall Mount Kit PRVMA-XX=Mast Arm Mounting Kit PRVSA-XX=Standard Arm Mounting Kit HS/VERD=House Side Shield MA1010-XX=Single Tenon Adapter for 3-1/2" O.D. Tenon MA1011-XX=2@180° Tenon Adapter for 3-1/2" O.D. Tenon MA1012-XX=3@120° Tenon Adapter for 3-1/2" O.D. Tenon MA1013-XX=4@90° Tenon Adapter for 3-1/2" O.D. Tenon MA1014-XX=2@90° Tenon Adapter for 3-1/2" O.D. Tenon MA1015-XX=2@120° Tenon Adapter for 3-1/2" O.D. Tenon MA1016-XX=3@90° Tenon Adapter for 3-1/2" O.D. Tenon MA1017-XX=Single Tenon Adapter for 2-3/8" O.D. Tenon MA1018-XX=2@180° Tenon Adapter for 2-3/8" O.D. Tenon MA1019-XX=3@120° Tenon Adapter for 2-3/8" O.D. Tenon MA1045-XX=4@90° Tenon Adapter for 2-3/8" O.D. Tenon MA1048-XX=2@90° Tenon Adapter for 2-3/8" O.D. Tenon MA1049-XX=3@90° Tenon Adapter for 2-3/8" O.D. Tenon MA1191-XX=2@120° Tenon Adapter for 2-3/8" O.D. Tenon OA/RA1013=Photocontrol Shorting Cap OA/RA1014=NEMA Photocontrol - 120V OA/RA1016=NEMA Photocontrol - Multi-Tap 105-285V OA/RA1027=NEMA Photocontrol - 480V OA/RA1201=NEMA Photocontrol - 347V ISHH-01=Integrated Sensor Programming Remote		

- NOTES:**
- Customer is responsible for engineering analysis to confirm pole and fixture compatibility for all applications. Refer to installation instructions IB500002EN and pole white paper WP513001EN for additional support information.
  - DesignLights Consortium® Qualified and classified for DLC Standard, refer to www.designlights.org for details.
  - Standard 4000K CCT and 70 CRI.
  - Consult factory for driver surge protection values.
  - Only for use with 480V Wye systems. Per NEC, not for use with ungrounded systems, impedance grounded systems or corner grounded systems (commonly known as Three Phase Three Wire Delta, Three Phase High Leg Delta and Three Phase Corner Grounded Delta systems).
  - Different housing colors impact lumen output. IES files for the non-standard colors are available upon request.
  - Extended lead times apply. Use dedicated IES files for 3000K and 5000K when performing layouts. These files are published on the Prevail luminaire product page on the website.
  - LumaWatt Pro wireless sensors are factory installed and require network components LWP-EM-1, LWP-GW-1, and LWP-PoE8 in appropriate quantities. See website for LumaWatt Pro application information.
  - LumaWatt Pro wireless system is not available with photocontrol receptacle (Not needed).
  - Not available in conjunction with A60 lumen package at HA (High Ambient).
  - Not available with MSP or LWR options.
  - Replace XX with paint color.

**STOCK ORDERING INFORMATION**

Stock Sample Number: PRVS-A25-UNV-T3

Product Family	Light Engine	Voltage	Distribution	Options (Add as Suffix)
PRVS=Prevail	A15=(1 LED) 6,100 Nominal Lumens A25=(2 LEDs) 10,200 Nominal Lumens A40=(2 LEDs) 15,100 Nominal Lumens A60=(2 LEDs) 18,900 Nominal Lumens	UNV=Universal (120-277V) 347=347V	T3=Type III T4=Type IV	MSP/DIM-L30=Integrated Sensor for Dimming Operation, Maximum 30' Mounting Height

NOTE: Bronze only, 4000K CCT, 120-277V, 347V, standard mounting arm, standard non-fused 10kV MOV and 0-10V dimming.