

# OPTOTRONIC® Power Supply OT96W/24V/UNV/DIM



## GENERAL INFORMATION

Item Number	51520
Type	Constant Voltage
Output Power	96W (Max.)
Output Voltage	24V DC
Input	Universal (120-277V)

## ELECTRICAL SPECIFICATIONS

### Input

Input Voltage (VAC)	120V-277V (+/- 10%)
Frequency Range (Hz)	50 – 60 Hz (+/- 10%)
Input Current (A)	0.91 @ 120V 0.39 @ 277V
Input Power (W)	111W
THD	< 20%
Power Factor	> 0.95
Inrush Current (A <sub>pk</sub> )	< 55A
Line Regulation	< 5%
Stand-by Power (W)	< 1.5W

### Output

Output Voltage (VDC)	24V (+/- 5%)
Output Current (A)	0.1 – 4.0A
Output Ripple (V)	1V
Efficiency	>85% (Typical)
Load Regulation	<5%

## DIMMING

Dimming Control	0 – 10V
Dimming Range	10 – 100%
Dimming Type	PWM
Frequency	250Hz
Dimming Input Isolation	2.5KV

## ENVIRONMENTAL SPECIFICATIONS

Ambient Operating Temp	-25 to 40 °C
Max. Case Temp. T <sub>c</sub>	75°C
Storage Temp.	-25 to 50 °C
Max. Relative Humidity (%)	96% non-condensing
Surge Protection (KV)	ANSI C62.41 Cat A (2.5KV)
Vibration Rating	3G
Overvoltage Protection	Yes
Short Circuit Protection	Yes
Over-temperature Protection	Yes
UL Environmental Rating	Damp
IP Rating	IP64
EMI Compliance	FCC Part 15 Class A

## WIRING DIAGRAM

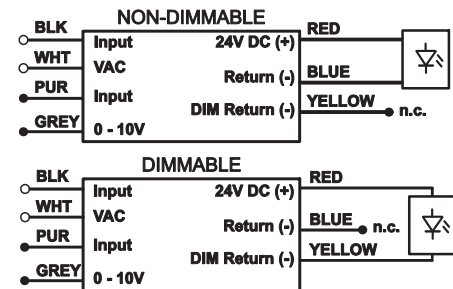

Note: Mounting distance for 18 AWG wire is 15 feet. For additional information on further distances and EMI compliance reference application note LED126.

## MECHANICAL DIAGRAM

Wiring	Leads Only
Wire Gauge	18AWG
Input Wire	6" (black & White)
Output	6" (red, blue & yellow)
Dimming Input	6" (purple & gray)

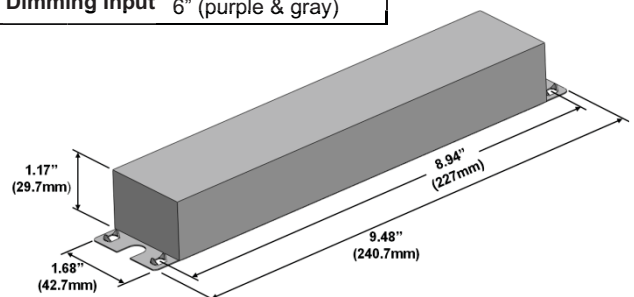

**TYPICAL EFFICIENCY**

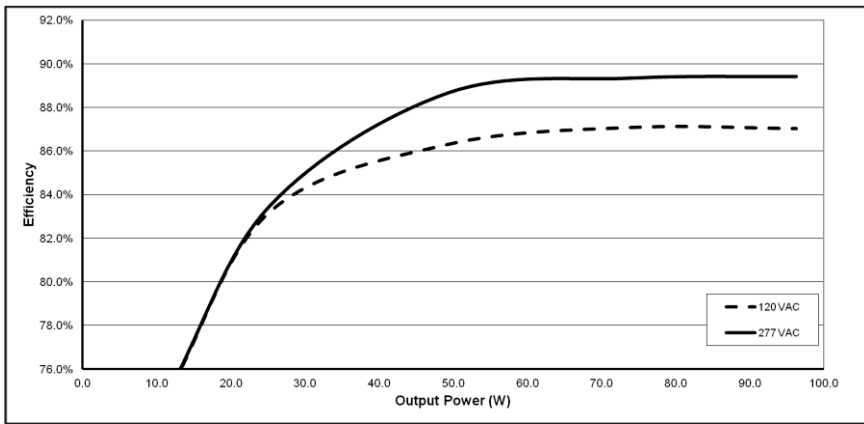

**TYPICAL POWER FACTOR**

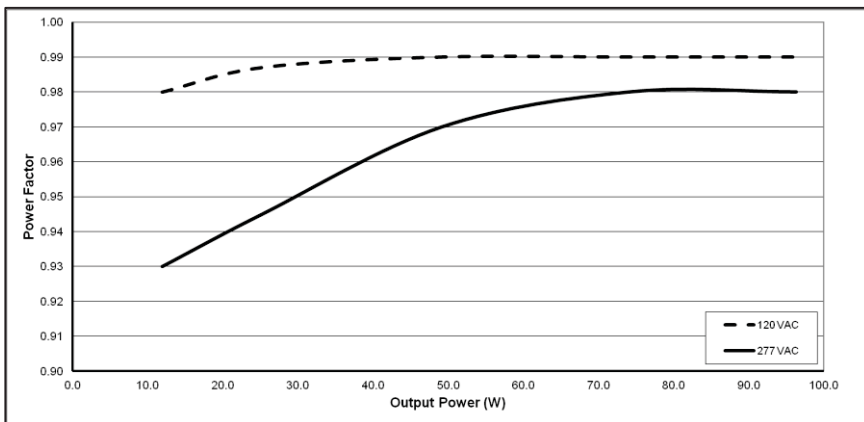

**TYPICAL THD**

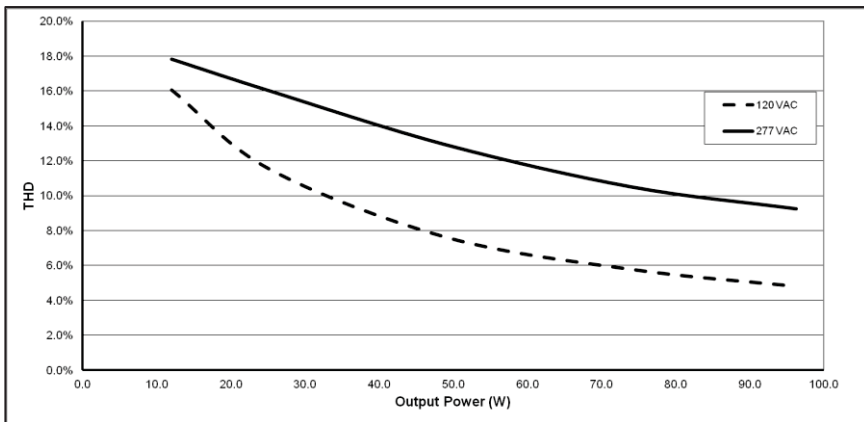

**WARRANTY**

OPTOTRONIC® products are covered by our LED Module, OPTOTRONIC Power Supply or Control Warranty. For additional details, refer to the latest version of the warranty available at [www.sylvania.com](http://www.sylvania.com).

**United States**

**OSRAM SYLVANIA**  
100 Endicott Street  
Danvers, MA 01923

**Trade**

Phone: 1-800-255-5042

Fax: 1-800-255-5043

**National Accounts**

Phone: 1-800-562-4671

Fax: 1-800-562-4674

**OEM/Special Markets**

Phone: 1-800-762-7191

Fax: 1-800-762-7192

**Display Optic**

Phone: 1-888-677-2627

Fax: 1-800-762-7192

**SYLVANIA Lighting Service**

Phone: 1-800-323-0572

Fax: 1-800-537-0784

**Canada**

**OSRAM SYLVANIA LTD./LTÉE**  
2001 Drew Road  
Mississauga, ON L5S 1S4

**Trade**

Phone: 1-800-263-2852

Fax: 1-800-667-6772

**OEM/Special Markets**

Phone: 1-800-265-2852

Fax: 1-800-667-6772

**SYLVANIA Lighting Service**

Phone: 1-800-663-4268

Fax: 1-866-239-1278

**Mexico**

**OSRAM Mexico**

Headquarters

Tultitlan/Edo de Mexico

011-52-55-58-99-18-50

SYLVANIA and SEE THE WORLD IN A NEW LIGHT are registered trademarks of OSRAM SYLVANIA Inc. OSRAM and OPTOTRONIC are registered trademarks of OSRAM AG. Specifications subject to change without notice 1-800-LIGHTBULB (1-800-544-4828)

# 96W Driver

POWER SUPPLY | 96ND-12X6X4

Remote Distance		Diameter	
7'-0"	(2.1m)	w/22 AWG	(.644mm)
18'-0"	(5.5m)	w/18 AWG	(1.02mm)
46'-0"	(14.0m)	w/14 AWG	(1.63mm)
71'-0"	(21.6m)	w/12 AWG	(2.05 mm)

100W	Max Run Length in Series		Max Run Lengths in Parallel	
line .75 - SO / ledge / luxrail	47'	(14.33m)	87'	(26.52m)
line .75 - HO / ledge / luxrail	12'	(3.66m)	23'	(7.018m)
line .75 - VHO (and color) / ledge	9'	(2.74m)	17'	(5.18m)
line 1.5 - SO	30'	(3.66m)	60'	(18.23m)
line 1.5 - HO	8'	(2.44m)	16'	(4.88m)
line 1.5 - VHO (and color)	6'	(1.82m)	12'	(3.66m)
line 2.0 - SO	26'	(7.92m)	26'	(7.92m)
line 2.0 - HO	17'	(5.18m)	17'	(5.18m)
line 2.0 - VHO	12'	(3.66m)	12'	(3.66m)
line 2.0 - V2HO / B / G / A	8'	(2.44m)	8'	(2.44m)
line 2.0 - R	6'	(1.82m)	6'	(1.82m)

# 12x6x4 Enclosure

## POWER SUPPLY | 100ND-12X6X4

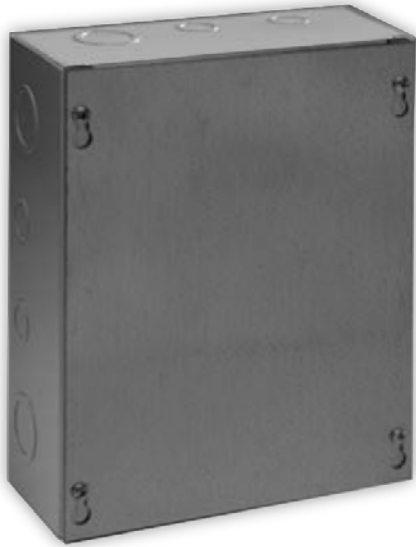

### Enclosure Construction

Enclosure and cover are fabricated from code 16 gauge steel. Enclosure body has mounting holes on the back and are available with or without knock outs on the sides, top and bottom ends. Cover is secured to the body with plated hex head combo screws, and has keyhole slots for easy removal without removing screws.

### Enclosure Industry Standards

- UL 50 Listed, Type 1
- CSA C22.2 No. 40 certified, Type 1
- Conforms to NEMA standard for Type 1
- IEC 60529, IP30

\*One driver enclosure can hold one 20W or 100W driver and one dimming module.

**Left End With Cover**



**Front View Without Cover**

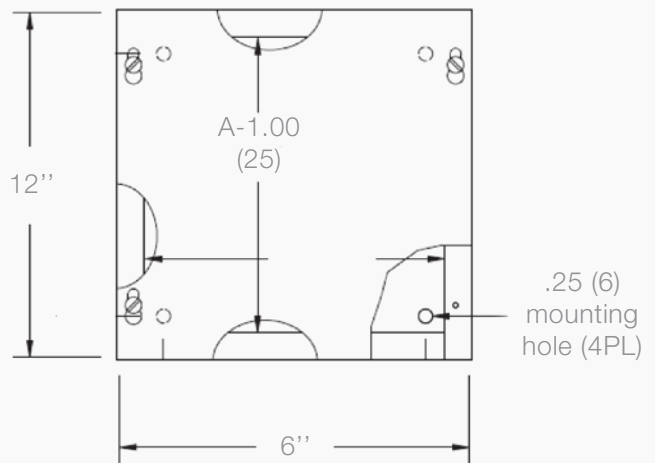

**Conduit Sizes**

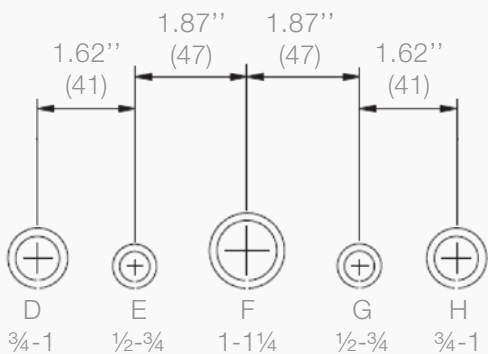

Note: Dimensions are in inches. Millimeters are for reference only. Data subject to change without notice.