

Installation Instructions For L-3703 AND L-3705

FOR USE WITH HALO TRACK SYSTEMS ONLY

To Adjust Halo-2 Series Lampholder

Halo-2 Lampholders can be used with Halo Miniature or Halo-2 Power-Trac systems. An adjustable contact allows you to select the circuit position. Use a narrow blade screwdriver, as shown, to adjust the contact. Lift or lower the contact until it touches the plastic stop of the contact assembly. For Circuit #1 move contact to the down position. For Circuit #2 move contact to the up position.

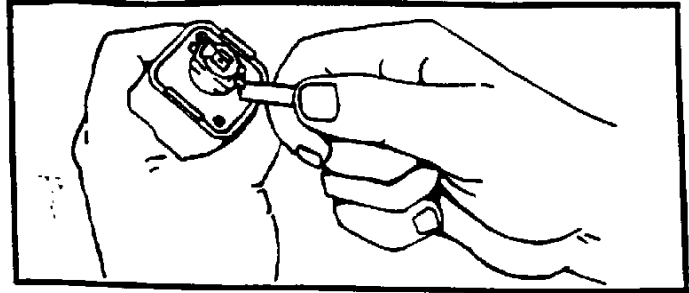

To Use Halo-2 Lampholder with Miniature Power-Trac

When using Halo-2 Lampholder with the Miniature Power-Trac System (L650, L651, L652, L653) adjustable contact must be in Circuit #1 (DOWN) position.

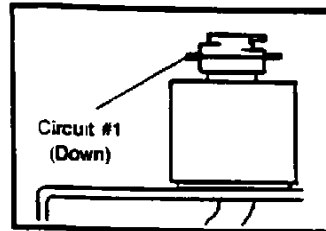

To Use Halo-2 Lampholder with Halo-2 Power-Trac

When using Halo-2 Lampholder with the Halo-2 Power-Trac System (L640, L641, L642, L643) adjust the contact position of each lampholder to the desired circuit — Circuit #1 (DOWN) or Circuit #2 (UP).

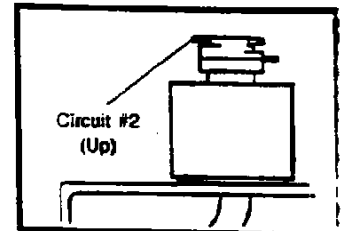
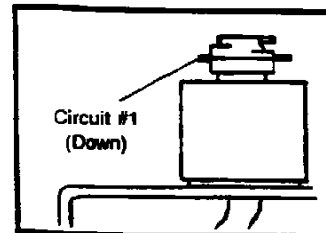

To Install Lampholder

Hold lampholder by the mounting adapter. Insert contact head into Power-Trac. Twist mounting adapter approximately 1/4 turn (90°) until mounting sleeve tab locks into Power-Trac opening.

NOTE: Forcing mounting adapter in wrong direction may damage the contact assembly! If mounting adapter will not turn easily, twist adapter in opposite direction. Polarity line on adapter must align with polarity line on Power-Trac for proper installation.

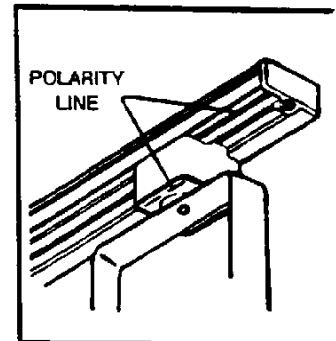
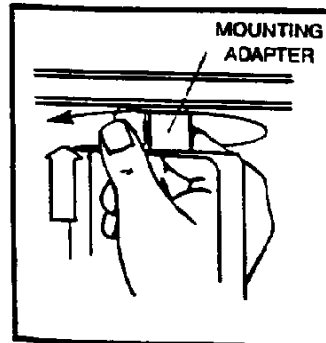

To Remove Lampholder

Pull down on mounting adapter sleeve until tab is free of track channel opening. Twist mounting adapter 1/4 turn (90°) until contact head is free and remove lampholder from track.

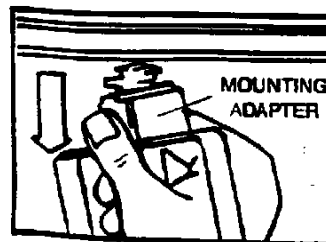

HALO LIGHTING

HALO LIGHTING
400 BUSSE ROAD
ELK GROVE VILLAGE, IL 60007

696674

6984

RELAMPING INSTRUCTIONS FOR L-3703 AND L-3705

WARNING: Before working on Power-Trac fixture be sure to turn off AC power or remove fixture from track.

Step 1: Allow fixture to cool and then remove from track.

Step 2: Remove lamp from gimbal ring.

Step 3: Turn lamp counter-clockwise and remove it from socket.

Step 4: Refer to relamping label on fixture for proper lamp replacement.

Step 5: Place lamp back in gimbal ring.

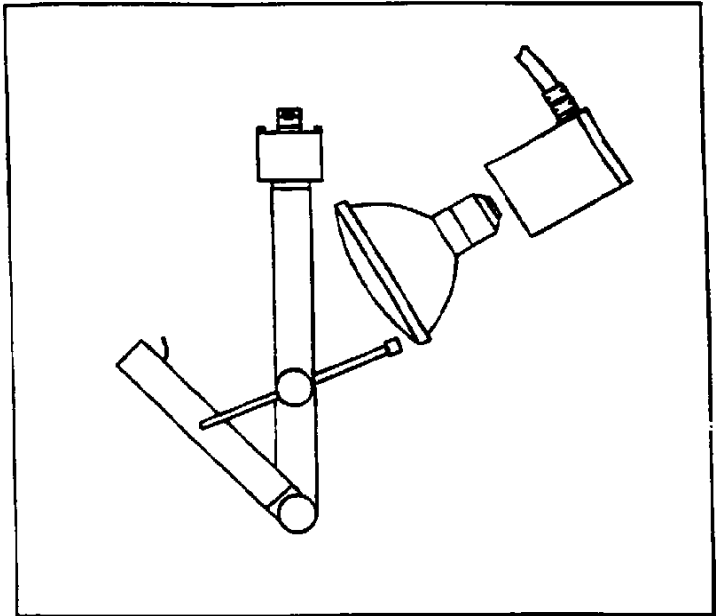

INSTALLATION INSTRUCTIONS FOR ATTACHING BARNDOOR L-1967 TO L-3703 OR L-3705

Step 1: Allow fixture to cool, remove from track, remove lamp from gimbal ring.

Step 2: Position clips (supplied with fixture) 120° apart and snap into the slots provided in the gimbal ring.

Step 3: Push barndoor into position on clips.

Step 4: If optional filter, lens or baffle is being used, install in front of barndoor as shown.

Step 5: Place lamp back in gimbal ring.

Step 6: Attach barndoor & fixture assembly to Power-Trac or appropriate adapter and bend barndoors to the desired position.

