

## DESCRIPTION

The Loft WaveStream™ luminaire merges classic styling with cutting-edge technology to provide quality illumination and superior optical control. Using the WaveStream LED direct/indirect light engine, its wide batwing distribution makes it an excellent choice for lower ceiling applications and areas where ceiling uniformity is important. Stringent building energy requirements are also met effortlessly with five standard output levels and efficacy up to 120 lumens per watt. Available in 4', 8' and 12' sections with a multitude of options, the Loft WaveStream is well suited for commercial office spaces, schools, libraries and other architectural interiors.

## SPECIFICATION FEATURES

### Construction

Extruded aluminum housing forming a 7-1/2" x 2-1/2" architectural profile. Modular 4'-0", 8'-0" and 12'-0" sections combine for continuous runs.

### End Caps

Standard end caps are precision die-cast aluminum, mechanically attached without exposed fasteners. End cap adds 1-3/4" at each end.

### Shielding

Bottom lens is a high light transmission 0.08" thick frosted acrylic material.

### Optics

Precision formed optical assembly with optical grade acrylic lenses provide an ideal direct/indirect optical distribution using WaveStream technology. Low voltage WaveStream LED light engine is field-replaceable.

### Electrical

Long-Life LED system coupled with electronic driver to deliver optimal performance. Projected life is 100,000 hours at 81% lumen output. LEDs are available in 3000K, 3500K or 4000K with a typical CRI

≥ 85. Standard drivers are 0-10 volt continuous dimming that work with any 0-10V control/dimmer. Or, specify Digital Addressable Lighting Interface (DALI) drivers; for use with Fifth Light controls. See ordering information for details.

### Mounting

Standard aircraft cable mounts on 4'-0", 8'-0" and 12'-0" centers. Refer to installation instructions for various ceiling interface details.

### Finish

Fixture housings are high reflectance white using electrostatically applied polyester powder coat paint.

### Compliance

Components are UL recognized and luminaires are cULus listed for 25°C ambient environments, damp location listed, and RoHS compliant. DesignLights Consortium™ Qualified and classified for DLC Standard, refer to [www.designlights.org](http://www.designlights.org) for details.

### Warranty

Five-year warranty.

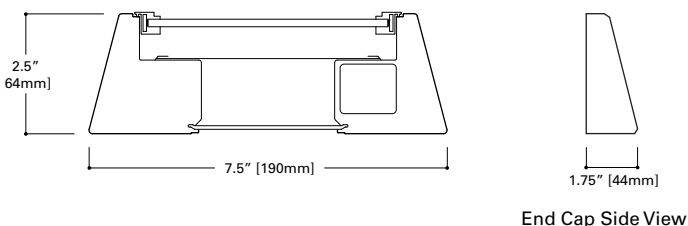

End Cap Side View

### Fixture Lengths

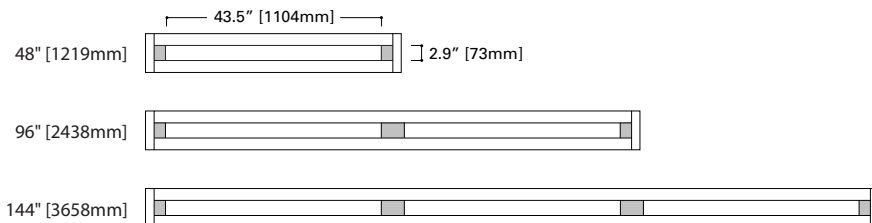

## ORDERING INFORMATION

Sample Number: L2-WS-3L35-1D-UNV-AC48-T1-56-STD-DM8-W

Series	Optics	Light Level (per 4' section, 3500K)	Color Temperature	Number of Circuits	Wiring	Input Voltage	Suspension/Power Feed
L2 = Loft Suspended	WS = WaveStream with frosted lens	1 = Light Level 1 (3,019 Lms, 26.1W) 2 = Light Level 2 (3,767 Lms, 35.5W) 3 = Light Level 3 (5,005 Lms, 46.3W) 4 = Light Level 4 (6,190 Lms, 63.7W) 5 = Light Level 5 (7,351 Lms, 79.2W)	L30 = LED 3000K L35 = LED 3500K L40 = LED 4000K	1 = 1 Circuit	C = Switched Circuit <sup>(1)</sup> D = Dimming <sup>(1)(2)</sup> B = Battery Pack <sup>(3)</sup> E = Emergency Circuit T = Nightlight Y = Daylight	UNV = Universal (120V-277V) 347 = 347V <sup>(4)</sup>	AC = Aircraft cable with straight power cord
Suspension Length	Ceiling Type	Run Length	Driver/Dimming Options	Integral Sensor (Optional)	Distribution Modifier Kit (DM Kit)	Finish	
Adjustable Cable 48", 120", 240", 300", or 360"	T1 = 1" T-Bar T9 = 9/16" T-Bar TS = Slotted T-Bar ST = Structure JB = 4" Octagonal J-Box	4 = 4 ft 8 = 8 ft 12 = 12 ft XX = Specify Row Length <sup>(5)</sup>	STD = Standard 0-10V (10%-100%) HCD = 0-10V (1%-100%) <sup>(7)</sup> 5LT = Fifth Light DALI (10%-100%) <sup>(6)(8)</sup> STP = Step Dimming (Bi-Level, 40%) <sup>(9)</sup> SR = Sensor Ready (5%-100%)	SVPD1 = Integrated Occupancy/Daylight Sensor for Local Control <sup>(10)(13)</sup> LWIPD1 = Lumawatt Pro Wireless Integral Sensor <sup>(11)(13)</sup> SWPD1 = WaveLinX Wireless Integral Sensor <sup>(12)(13)</sup>	(blank) = Std. 65% up / 35% down DM5 = 50% up / 50% down DM8 = 80% up / 20% down <i>Nominal distributions. Refer to photometric tests for exact distributions</i>	W = White S = Silver CC = Custom Color	

See page 3 for technical notes

Catalog #		Type
Project		
Comments		Date
Prepared by		



## LOFT - L2 Frosted Lens

WaveStream™ LED  
Suspended  
Direct/Indirect

CERTIFICATION DATA  
cULus - 1598  
Damp Location Listed  
LM79/LM80 Compliant  
ROHS Compliant  
DesignLights Consortium™ Qualified

LumaWatt Pro  
Wireless sensing & control system with **enlighted**



PHOTOMETRICS

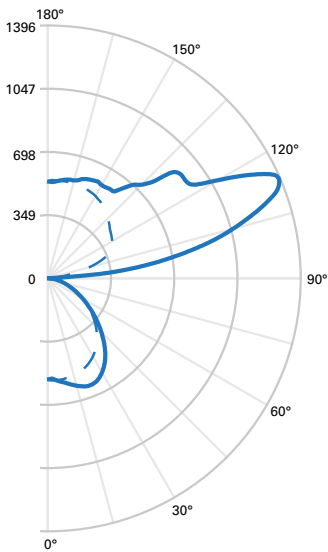

FILE NAME: L2-WS-3L35-1D-UNV-4-STD.IES

LAMP: (LD1) LED 3500K

LUMENS: 5005 Lm

WATTS: 46.3 W

EFFICACY: 108 Lm/W

TEST NO.: P183488

65% UP / 35% DOWN

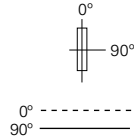

ZONAL LUMENS SUMMARY

Zone	Lumens	% Fixture
0°-30°	493	9.9
0°-90°	1742	34.8
90°-130°	1975	39.5
90°-180°	3263	65.2
0°-180°	5005	100

LUMINANCE DATA (CD/M<sup>2</sup>)

Vertical Angle	0°	45°	90°
45°	4354	4779	4577
55°	3944	4165	3742
65°	3493	3416	2975
75°	3033	2683	2294
85°	2702	1838	1298

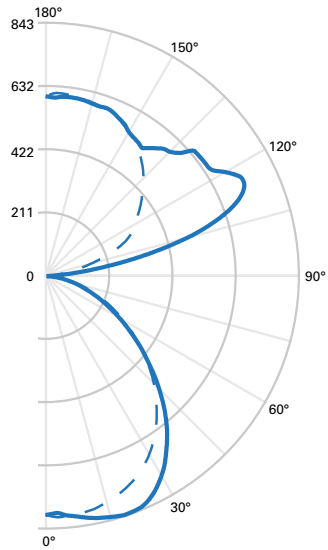

FILE NAME: L2-WS-3L35-1D-UNV-4-STD-DM5.IES

LAMP: (LD1) LED 3500K

LUMENS: 4681 Lm

WATTS: 46.3 W

EFFICACY: 101 Lm/W

TEST NO.: P183548

51% UP / 49% DOWN

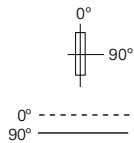

ZONAL LUMENS SUMMARY

Zone	Lumens	% Fixture
0°-30°	668	14.3
0°-90°	2271	48.5
90°-130°	1175	25.1
90°-180°	2411	51.5
0°-180°	4681	100

LUMINANCE DATA (CD/M<sup>2</sup>)

Vertical Angle	0°	45°	90°
45°	5842	6102	5794
55°	5204	5251	4753
65°	4608	4304	3767
75°	3946	3368	2892
85°	3428	2207	1623

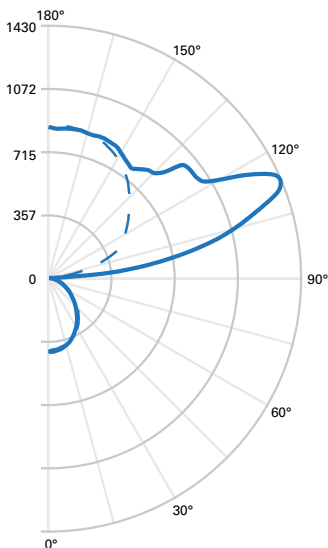

FILE NAME: L2-WS-3L35-1D-UNV-4-STD-DM8.IES

LAMP: (LD1) LED 3500K

LUMENS: 4876 Lm

WATTS: 46.3 W

EFFICACY: 105 Lm/W

TEST NO.: P183428

80% UP / 20% DOWN

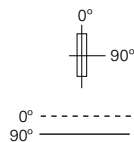

ZONAL LUMENS SUMMARY

Zone	Lumens	% Fixture
0°-30°	314	6.4
0°-90°	992	20.3
90°-130°	2121	43.5
90°-180°	3884	79.7
0°-180°	4876	100

LUMINANCE DATA (CD/M<sup>2</sup>)

Vertical Angle	0°	45°	90°
45°	2621	2475	2288
55°	2328	2121	1947
65°	2007	1777	1586
75°	1699	1419	1246
85°	1618	1101	757

## LUMEN MAINTENANCE

Ambient Temperature	TM-21 Lumen Maintenance (100,000 hours)	Theoretical L70 (Hours)
25°C	>81%	181,000

## ENERGY AND PERFORMANCE DATA

4' – L2 WaveStream Light Level Outputs and Distributions (3500K)						
Series	Light Level	Delivered Lumens	Wattage	Efficacy (LPW)	Distribution	
					% Up	% Down
L2-WS	1	3019	26.1	116	65%	35%
	2	3767	35.5	106		
	3	5005	46.3	108		
	4	6190	63.7	97		
	5	7351	79.2	93		
L2-WS w/ DM5	1	2824	26.1	108	51%	49%
	2	3524	35.5	99		
	3	4681	46.3	101		
	4	5790	63.7	91		
	5	6876	79.2	87		
L2-WS w/ DM8	1	2941	26.1	113	80%	20%
	2	3670	35.5	103		
	3	4876	46.3	105		
	4	6031	63.7	95		
	5	7161	79.2	90		

## TECHNICAL NOTES

- Dimming wires come standard in all LED fixtures but can be capped in the field for standard switched operation.
- When dimming is selected, a separate drop for low voltage control wires supplied as standard. A single drop may be supplied upon request.
- For approximate delivered lumens, take lumens per watt of desired fixture and multiply by 12 watts (100 lp/W x 12 = 1200 lumens delivered).
- Integral 347V electronic driver with STD 0-10V option only. Two drivers required for Light Level 5. Factory supplied remote transformer for all other driver/dimming options.
- Standard row configurations over 12' consist of 8' and 12' luminaires.
- Must be used in conjunction with a DALI control system. For a complete listing of Fifth Light Technology products and other solutions from Cooper Lighting Solutions, visit [www.cooperlighting.com](http://www.cooperlighting.com)
- Two HCD drivers required per 4' section for Light Levels 4 and 5.
- Two Fifth Light (5LT) drivers required per 4' section for Light Level 5.
- Step-dim not available in Light Level 1. Two step-dim drivers required per 4' section for Light Level 5.
- SV sensor works only with 0-10V drivers and is factory prewired to the driver for stand-alone control. Individual fixtures only. Order **#ISHH-01** for Programming Remote and **#ISHH-02** for Personal Control Remote.
- LWI sensor requires use of SR driver. Must be used in conjunction with a LumaWatt Pro control system. For complete LumaWatt Pro wireless solutions, visit [www.cooperlighting.com](http://www.cooperlighting.com)
- SW sensor works only with STD and HCD 0-10V drivers. Designed for use with the WaveLinX Wireless Connected Lighting system. For complete WaveLinX wireless solutions, visit [www.cooperlighting.com](http://www.cooperlighting.com)
- Integrated Sensors combined with Emergency Circuit require one UL924 Bypass Relay per emergency section to disable sensor control when normal power is lost.

**SVPD1 INTEGRATED SENSOR**

The Loft with Integrated Sensor technology provides automatic energy savings without sacrificing performance. Traditionally, these types of energy savings required coordination between the luminaire and a lighting control system. The Loft delivers superior lighting with integrated PIR occupancy sensing and daylighting controls.

Capture the benefits of traditional lighting controls, without complicated coverage planning or special wiring. Ideal for new construction or retrofit, the Loft delivers automatic ON to an energy saving light level, while ensuring lighting is turned OFF when the space is unoccupied.

The integral daylight sensors reduce the need for special daylight zone planning. The luminaire will automatically adjust the light level based on reflected light beneath the sensor in a closed loop method.

Occupied daylight light levels and unoccupied light levels can be adjusted using the integrated sensor programming remote (Catalog Number: ISHH-01). The integrated sensor personal remote (Catalog Number: ISHH-02) provides code compliant manual raise, lower, ON, OFF control.

The Loft with Integrated Sensors is easy to install with no special wiring and ensures energy savings out-of-the-box with default control settings.

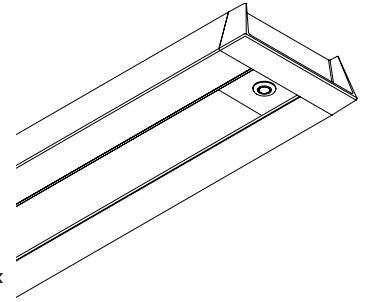

**How it works:**

- When a user enters under an integral sensor, the luminaire controlled by that sensor turns ON to the daylight level (default 500 lux).
- Lighting will remain at the daylight level until the space is unoccupied. This will start the occupancy timeout period (default 20 minutes).
- If the space remains unoccupied for half of the timeout period, the lighting will automatically reduce to the Energy Saver light level (default matches occupied daylight level). This adjustable light level is often set to half of the occupied daylight level.
- At the end of the timeout period the lighting will go to the unoccupied light level. This adjustable light level uses the OFF default setting.

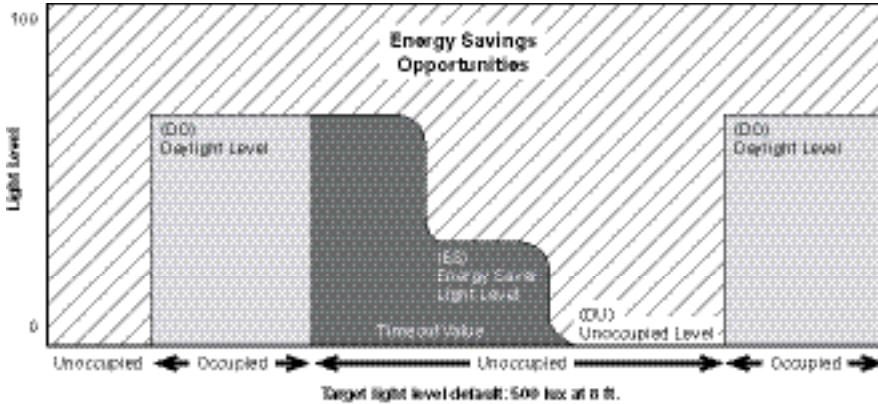

**Coverage**

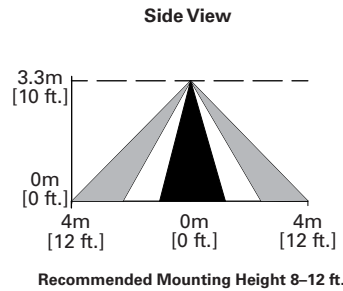
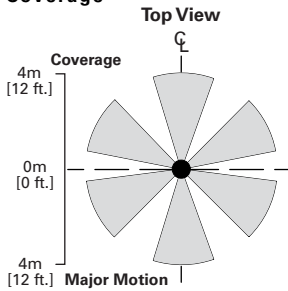

**Optional Remote Controls**



**ISHH-01 Programming Remote**



**ISHH-02 Personal Control Remote**