

KwikSplice™ cable tray system Tab and lock trapeze support

Features & Benefits

- Designed for KwikSplice cable tray system
- Rated for maximum load of KwikSplice cable tray system
- Accepts up to 3/8" rod
- Tabs clamp cable tray to trapeze support
- Accepts traditional hold down clamps (9ZN-1204) if necessary
- Pre-galvanized steel

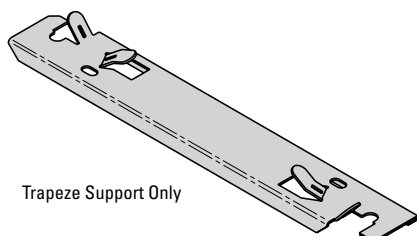

Trapeze Support Only

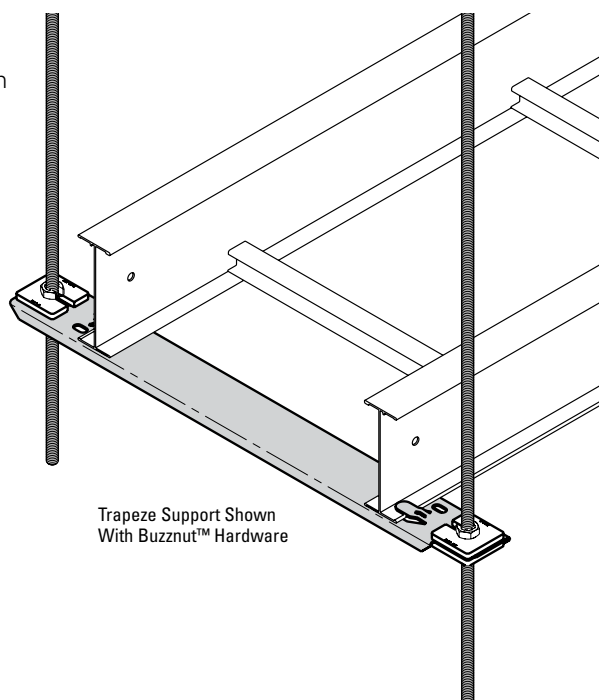

Trapeze Support Shown With Buzznut™ Hardware

Catalog #	Tray Width	
	in	mm
KSA-6CT	6"	152
KSA-9CT	9"	229
KSA-12CT	12"	305
KSA-18CT	18"	457
KSA-24CT	24"	610
KSA-30CT	30"	762
KSA-36CT	36"	914

Catalog #	Qty.	Hardware
B201	4	Standard
3/8" HN	4	Standard

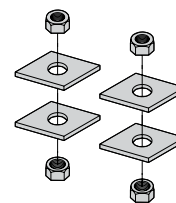

Standard Hardware

- OR -

Catalog #	Qty.	Hardware
SLWN3/8	4	Buzznut

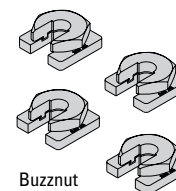

Buzznut Hardware

Installation

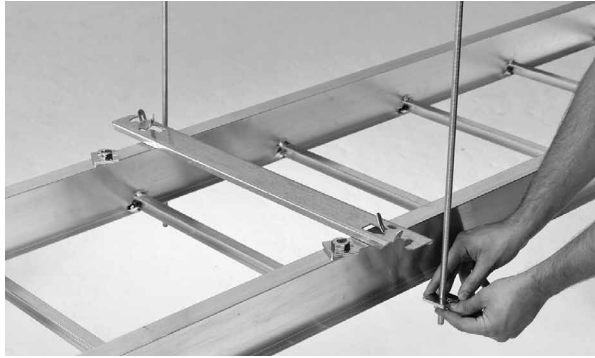

- 1** Install hardware on threaded rod to desired position.

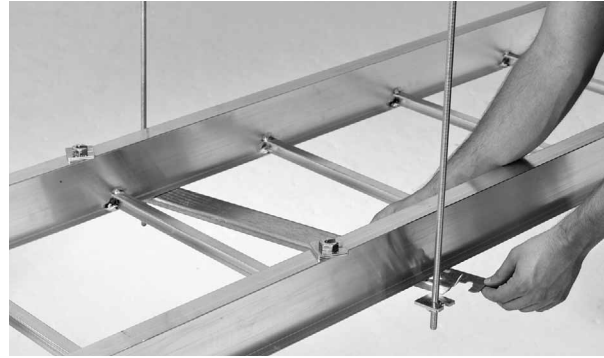

- 2** Insert flat head screwdriver into tab slots and open tabs to accept threaded rod and cable tray.

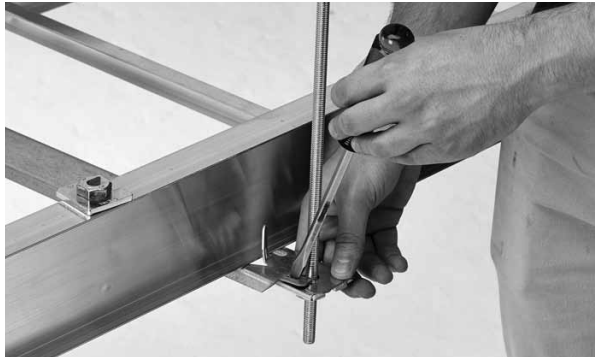

- 3** Position trapeze onto threaded rod and close tabs using the flat head screwdriver.



- 4** Once cable tray is positioned properly, close remaining tabs to clamp the cable tray to the trapeze support.



- 5** Install top threaded rod hardware locking the trapeze tabs into position.

Eaton
1000 Eaton Boulevard
Cleveland, OH 44122
United States
Eaton.com

© 2014 Eaton
All Rights Reserved
Printed in USA
Publication No. CTIS-19
September 2014

Eaton's B-Line Business
509 West Monroe Street
Highland, IL 62249
United States
Phone: 800-851-7415

www.cooperbline.com/contactus

Eaton is a registered trademark.

All other trademarks are property of their respective owners.