

New Product



Enclosures

**Quick-Connect Hinged Cover
Wireway & Accessories**

ENCRHCW-07

COOPER B-Line



Type 1 Hinged Cover Wireway - Data Sheet

Features & Benefits

Increased ease, flexibility and speed of installation on the job site

Features

Benefits



No Loose Hardware

Manufacturer installed cover and connector hardware provides an easier and quicker installation.



**Easily Removable & Reversible
Hinging Screw Down Cover**

The removable and reversible cover provides flexibility and improved cable access, while the screw connection provides secure closure.

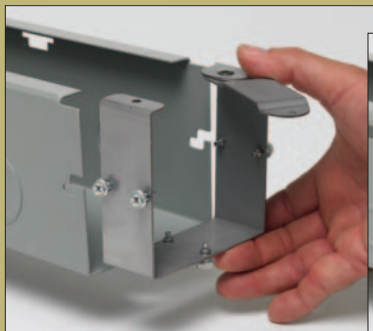

Quick Connection Method

A slide in connector with manufacturer installed hardware eliminates the hassle of handling hardware and attaching blind connections, significantly reducing connector installation time (at least a 75% time reduction).

For time study information go to www.cooperblineline.com/pdf/flyers/ENCRHCWTS-07.pdf

Type 1 Hinged Cover Wireway - Data Sheet

Step-By-Step Connector Installation

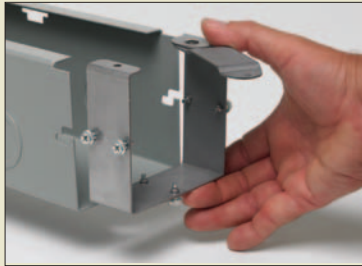

Align connector
with wireway



Slide connector
into position



Tighten wireway
to connector



Align next
wireway and slide
onto connector



Tighten wireway
to connector

Application

- Houses runs of control and power cables
- Used for cable and wire junction, distribution and termination.

Standards

- UL 870 Listed, Type 1
- CSA C22.2 No. 26 certified, Type 1
- Conforms to NEMA standard for Type 1
- IEC 60529, IP30

Finish

- Wash and phosphate undercoat
- ANSI 61 gray acrylic electrocoat finish

Accessories

- Touch-up paint

Construction

- Patent(s) Pending
- Body and cover are fabricated from code gauge steel, (see table)
- Body has mounting holes on the back
- Available with or without knockouts on the top and bottom sides
- Fittings have no knockouts, ends are available with or without knockouts
- Wireway exceeding 72 inches in length has two overlapping covers
- Variety of fittings allow runs which can change directions, junction and terminate
- Connectors (sold separately) have a unique gate feature which can swing completely open allowing lay-in of wire and cable
- Wireway adapter kits are available for connecting to traditional Cooper B-Line screw and hinge cover wireway systems.

Service

- SD Code = Service Delivery Code
 - A = 1-2 days
 - B = 2-5 days
 - C = 5-10 days
 - D = 10-15 days
 - E = 15-20 days
- (S) Items likely to be available from stock

Type 1 Hinged Cover Wireway - Data Sheet

Wireway UPC Number		Wireway Catalog Number		Wireway Size Height x Depth x Length A x B x C (in.)	Bottom Mtg. Hole Spacing D (in.)	Gauge	Knockout Quantity		List Price Dollars (each)	SD Code	
KO	No KO	KO	No KO				Top	Bottom		KO	No KO
782051 47789	782051 47898	4412 HS	4412 HS NK	4.0 x 4.0 x 12.0	2.75	16	3	3	22.81	C	C
782051 47793	782051 47900	4424 HS	4424 HS NK (S)	4.0 x 4.0 x 24.0	2.75	16	7	7	36.16	C	A
782051 47795	782051 47901	4436 HS	4436 HS NK (S)	4.0 x 4.0 x 36.0	2.75	16	11	11	54.78	D	A
782051 47796	782051 47902	4448 HS	4448 HS NK (S)	4.0 x 4.0 x 48.0	2.75	16	15	15	73.24	C	A
782051 47797	782051 47903	4460 HS	4460 HS NK (S)	4.0 x 4.0 x 60.0	2.75	16	19	19	78.10	E	A
782051 47798	782051 47904	4472 HS	4472 HS NK	4.0 x 4.0 x 72.0	2.75	16	23	23	97.94	E	D
782051 47799	782051 47905	44120 HS (S)	44120 HS NK (S)	4.0 x 4.0 x 120.0	2.75	16	39	39	168.42	A	A
782051 47801	782051 47906	6612 HS	6612 HS NK	6.0 x 6.0 x 12.0	4.25	16	3	3	43.26	E	D
782051 47803	782051 47908	6624 HS	6624 HS NK (S)	6.0 x 6.0 x 24.0	4.25	16	7	7	58.20	C	A
782051 47805	782051 47909	6636 HS	6636 HS NK (S)	6.0 x 6.0 x 36.0	4.25	16	11	11	78.36	C	A
782051 47806	782051 47910	6648 HS	6648 HS NK (S)	6.0 x 6.0 x 48.0	4.25	16	15	15	105.70	C	A
782051 47807	782051 47911	6660 HS	6660 HS NK (S)	6.0 x 6.0 x 60.0	4.25	16	19	19	114.80	D	A
782051 47808	782051 47912	6672 HS	6672 HS NK	6.0 x 6.0 x 72.0	4.25	16	23	23	145.53	E	C
782051 47810	782051 47913	66120 HS (S)	66120 HS NK (S)	6.0 x 6.0 x 120.0	4.25	16	39	39	272.27	B	A
782051 47812	782051 47914	8812 HS	8812 HS NK	8.0 x 8.0 x 12.0	6.00	14	3	3	73.70	E	E
782051 47814	782051 47916	8824 HS	8824 HS NK	8.0 x 8.0 x 24.0	6.00	14	7	7	111.62	D	C
782051 47815	782051 47917	8836 HS	8836 HS NK	8.0 x 8.0 x 36.0	6.00	14	11	11	171.36	D	C
782051 47816	782051 47918	8848 HS	8848 HS NK	8.0 x 8.0 x 48.0	6.00	14	15	15	207.06	D	C
782051 47817	782051 47919	8860 HS	8860 HS NK (S)	8.0 x 8.0 x 60.0	6.00	14	19	19	233.31	E	B
782051 47818	782051 47920	8872 HS	8872 HS NK	8.0 x 8.0 x 72.0	6.00	14	23	23	297.80	E	E
782051 47819	782051 47922	88120 HS	88120 HS NK (S)	8.0 x 8.0 x 120.0	6.00	14	39	39	486.47	E	A
782051 47820	782051 47923	101012 HS	101012 HS NK	10.0 x 10.0 x 12.0	8.00	14	3	3	92.08	E	E
782051 47822	782051 47926	101024 HS	101024 HS NK	10.0 x 10.0 x 24.0	8.00	14	7	7	160.68	E	E
782051 47823	782051 47927	101036 HS	101036 HS NK	10.0 x 10.0 x 36.0	8.00	14	11	11	223.26	E	E
782051 47824	782051 47928	101048 HS	101048 HS NK	10.0 x 10.0 x 48.0	8.00	14	15	15	281.51	E	E
782051 47825	782051 47929	101060 HS	101060 HS NK	10.0 x 10.0 x 60.0	8.00	14	19	19	345.45	E	E
782051 47827	782051 47931	1010120 HS	1010120 HS NK	10.0 x 10.0 x 120.0	8.00	14	39	39	721.36	D	D
782051 47828	782051 47932	121212 HS	121212 HS NK	12.0 x 12.0 x 12.0	10.00	14	3	3	109.44	E	E
782051 47830	782051 47934	121224 HS	121224 HS NK	12.0 x 12.0 x 24.0	10.00	14	7	7	196.35	E	E
782051 47831	782051 47935	121236 HS	121236 HS NK	12.0 x 12.0 x 36.0	10.00	14	11	11	291.59	E	E
782051 47832	782051 47936	121248 HS	121248 HS NK	12.0 x 12.0 x 48.0	10.00	14	15	15	350.07	E	E
782051 47833	782051 47937	121260 HS	121260 HS NK	12.0 x 12.0 x 60.0	10.00	14	19	19	405.72	E	C
782051 47835	782051 47939	1212120 HS	1212120 HS NK	12.0 x 12.0 x 120.0	10.00	14	39	39	841.89	E	D

(S) Items likely to be available from stock.
SD Code = Service Delivery Code

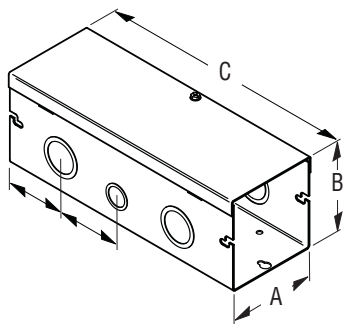

Wireway Section

Lengths from 12.00" to 120.00".
Wireway exceeding 72.00" has two covers.
Shown with KO's, also available without.

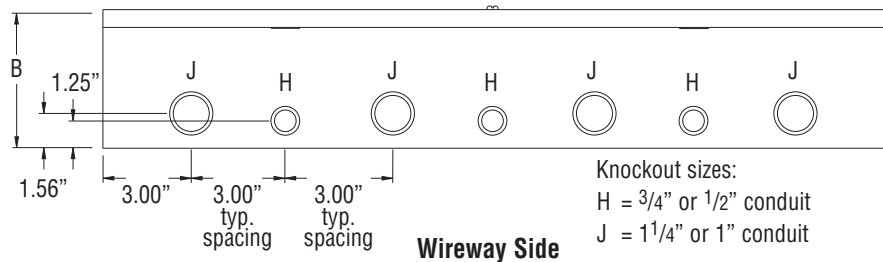
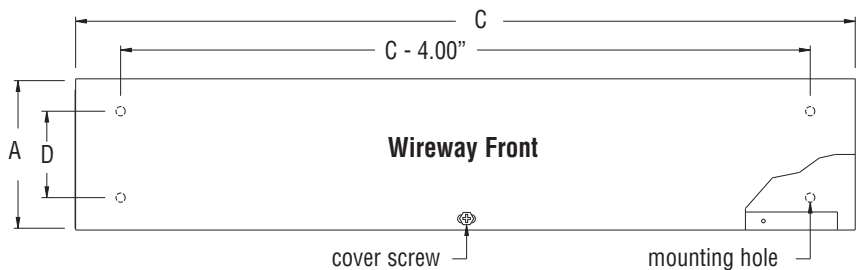

Type 1 Hinged Cover Wireway Accessories - Data Sheet

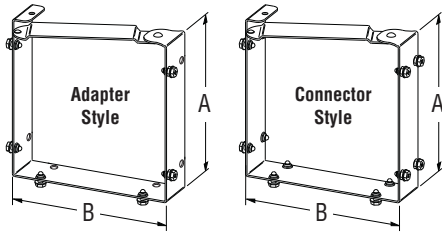

Adapters & Connectors

Swing gate allows for continuous runs of wire and cable.

Wireway Connector UPC Number		Wireway Connector Catalog Number		A (in.)	B (in.)	List Price Dollars (each)	SD Code	
Adapter Style	Connector Style	Adapter Style	Connector Style				Adapter	Connector
782051 47942	782051 47842	44 HSCA (S)	44 HSC (S)	4.00	4.00	7.23	A	A
782051 47943	782051 47846	66 HSCA (S)	66 HSC (S)	6.00	6.00	10.54	A	A
782051 47944	782051 47848	88 HSCA (S)	88 HSC (S)	8.00	8.00	14.40	A	A
782051 47945	782051 47949	1010 HSCA	1010 HSC	10.00	10.00	22.38	C	C
782051 47946	782051 47850	1212 HSCA	1212 HSC	12.00	12.00	30.25	C	C

Adapter style is designed to join the quick-connect hinged cover wireway to traditional screw or hinged cover wireways.

Note: To utilize quick connect feature, adjoining covers must line up.

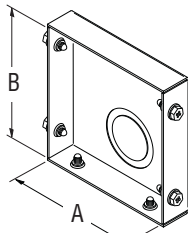

End

Used to terminate wireway or fitting. Shown with KO, also available without.

Wireway UPC Number		Wireway Catalog Number		A (in.)	B (in.)	KO Size (in.)	List Price Dollars (each)	SD Code	
KO	No KO	KO	No KO					KO	No KO
782051 47952	782051 47947	44 HSE (S)	44 HSENK (S)	4.00	4.00	1.50	7.34	A	A
782051 47953	782051 47948	66 HSE (S)	66 HSENK (S)	6.00	6.00	1.50	10.54	A	A
782051 47954	782051 47949	88 HSE (S)	88 HSENK (S)	8.00	8.00	1.50	14.40	A	A
782051 47955	782051 47950	1010 HSE	1010 HSENK	10.00	10.00	3.00	23.06	C	C
782051 47956	782051 47951	1212 HSE	1212 HSENK	12.00	12.00	3.00	32.64	C	C

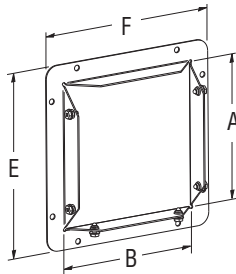

Wireway End Flange

Allows for a secure connection of wireway to an adjoining enclosure or wall.

Wireway End Flange UPC Number	Wireway End Flange Catalog Number	A (in.)	B (in.)	E (in.)	F (in.)	List Price Dollars (each)	SD Code
782051 48029	44 HSF	4.00	4.00	5.50	5.50	21.56	D
782051 48031	66 HSF	6.00	6.00	7.50	7.50	30.01	D
782051 48032	88 HSF	8.00	8.00	9.50	9.50	43.73	D
782051 48033	1010 HSF	10.00	10.00	11.50	11.50	66.36	E
782051 48034	1212 HSF	12.00	12.00	13.50	13.50	89.79	E

Wireway Hangers

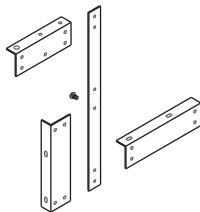

(shipped unassembled)

Wireway Hanger UPC Number	Wireway Hanger Catalog Number	G (in.)	H (in.)	J (in.)	K (in.)	List Price Dollars (each)	SD Code
782051 10922	44 FH (S)	12.50	10.50	10.37	4.87	17.22	A
782051 10924	66 FH (S)	16.50	14.50	13.50	5.87	27.21	A
782051 10926	88 FH (S)	20.50	18.50	16.75	6.87	37.94	A
782051 10873	1010 FH *	24.50	22.50	17.25	7.87	70.55	D
782051 10896	1212 FH *	28.50	26.50	20.25	8.87	83.81	D

* Hangers are shipped welded in the top cover assembly position.

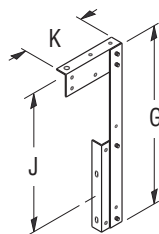

Side Cover Assembly

For those installations where the wireway cover must be hinged at the side.

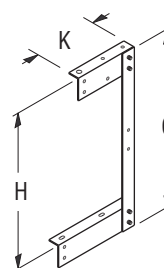

Top Cover Assembly

For those installations where the wireway cover must be hinged at the top.

Type 1 Hinged Cover Wireway Accessories - Data Sheet

Wireway 90° Elbow UPC Number	Wireway 90° Elbow Catalog Number	A (in.)	B (in.)	E (in.)	F (in.)	List Price Dollars (each)	SD Code
782051 47985	44 HSLIN (S)	4.00	4.00	6.00	6.00	61.38	A
782051 47986	66 HSLIN (S)	6.00	6.00	7.00	7.00	68.94	A
782051 47987	88 HSLIN	8.00	8.00	8.00	8.00	107.96	C
782051 47988	1010 HSLIN	10.00	10.00	9.00	9.00	146.11	E
782051 47989	1212 HSLIN	12.00	12.00	10.00	10.00	192.36	E
782051 47962	44 HSL OUT (S)	4.00	4.00	6.00	6.00	61.38	A
782051 47963	66 HSL OUT (S)	6.00	6.00	7.00	7.00	68.94	A
782051 47964	88 HSL OUT	8.00	8.00	8.00	8.00	107.96	C
782051 47965	1010 HSL OUT	10.00	10.00	9.00	9.00	146.11	E
782051 47966	1212 HSL OUT	12.00	12.00	10.00	10.00	192.36	E
782051 48013	44 HSL SIDE (S)	4.00	4.00	6.00	6.00	61.38	A
782051 48014	66 HSL SIDE (S)	6.00	6.00	7.00	7.00	68.94	A
782051 48015	88 HSL SIDE	8.00	8.00	8.00	8.00	107.96	C
782051 48016	1010 HSL SIDE	10.00	10.00	9.00	9.00	146.11	E
782051 48017	1212 HSL SIDE	12.00	12.00	10.00	10.00	192.36	E

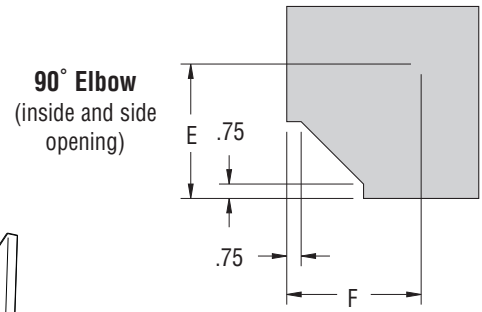
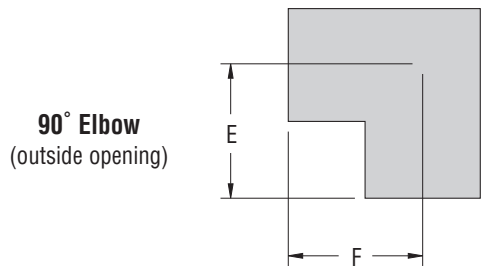

Wireway 90° Elbows

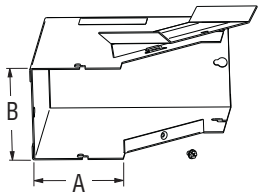

Inside Opening

Specifically designed to have only the inside cover hinge open to allow a continuous run with 90° turns.

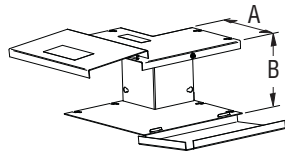

Outside Opening

Specifically designed to have the outside covers hinge open to allow a continuous run with 90° turns.

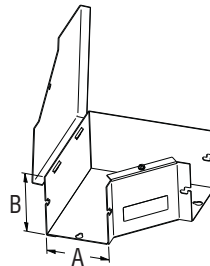

Side Opening

Side cover is hinged to allow a continuous run on designs with 90° sweeping turns.

Wireway 45° Elbow UPC Number	Wireway 45° Elbow Catalog Number	A (in.)	B (in.)	E (in.)	F (in.)	List Price Dollars (each)	SD Code
782051 47973	4445 HSL COMBO (S)	4.00	4.00	2.75	2.75	58.53	A
782051 47974	6645 HSL COMBO (S)	6.00	6.00	3.18	3.18	67.61	A
782051 47975	8845 HSL COMBO	8.00	8.00	3.62	3.62	103.12	C
782051 47978	101045 HSL COMBO	10.00	10.00	4.06	4.06	133.16	E
782051 47979	121245 HSL COMBO	12.00	12.00	4.50	4.50	188.06	E
782051 48022	4445 HSL SIDE	4.00	4.00	2.75	2.75	58.53	D
782051 48023	6645 HSL SIDE	6.00	6.00	3.18	3.18	67.61	D
782051 48024	8845 HSL SIDE	8.00	8.00	3.62	3.62	103.12	D
782051 48025	101045 HSL SIDE	10.00	10.00	4.06	4.06	133.16	E
782051 48026	121245 HSL SIDE	12.00	12.00	4.50	4.50	187.59	E

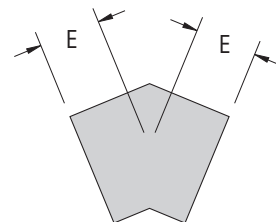

Wireway 45° Elbows

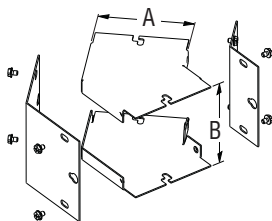

Combo Opening

Designed to achieve a 45° turn. Inside and outside removable covers are secured with screws.

Side Opening

Designed to achieve a 45° turn and have the cover removed from the side. Excellent for combining two to make a gradual 90° sweep.

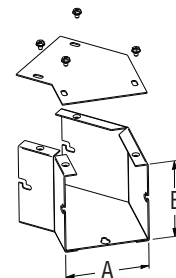

(S) Items likely to be available from stock.
SD Code = Service Delivery Code

For millimeters (mm) multiply the inches (in.) times 25.4

Type 1 Hinged Cover Wireway Accessories - Data Sheet

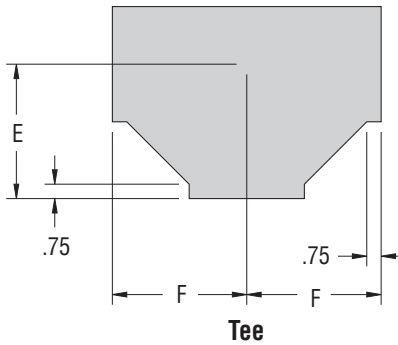

Wireway Tee UPC Number	Wireway Tee Catalog Number	A (in.)	B (in.)	E (in.)	F (in.)	List Price Dollars (each)	SD Code
782051 47999	44 HST (S)	4.00	4.00	6.00	6.00	70.43	A
782051 48001	66 HST (S)	6.00	6.00	7.00	7.00	78.75	A
782051 48002	88 HST	8.00	8.00	8.00	8.00	112.64	C
782051 48003	1010 HST	10.00	10.00	9.00	9.00	315.11	E
782051 48004	1212 HST	12.00	12.00	10.00	10.00	362.59	E

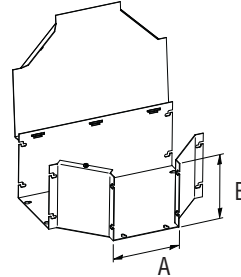

Tee

Side hinge cover design for applications where a "T" junction is necessary.

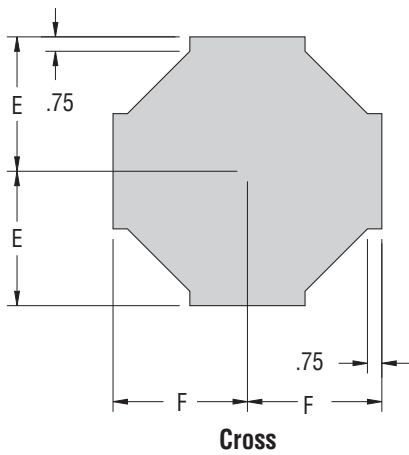

Wireway Cross UPC Number	Wireway Cross Catalog Number	A (in.)	B (in.)	E (in.)	F (in.)	List Price Dollars (each)	SD Code
782051 48008	44 HSX	4.00	4.00	6.12	6.12	68.94	D
782051 48009	66 HSX	6.00	6.00	7.12	7.12	86.29	D
782051 48010	88 HSX	8.00	8.00	8.12	8.12	121.62	D
782051 48011	1010 HSX	10.00	10.00	9.12	9.12	261.92	E
782051 48012	1212 HSX	12.00	12.00	10.12	10.12	314.40	E

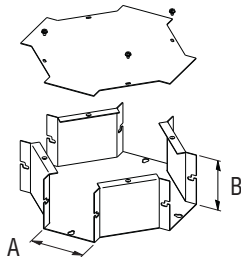

Cross

Side cover and broad body design to junction cable run in four directions. Removable cover is secured with screws.

Touch-Up Paint UPC Number	Touch-Up Paint Catalog Number	List Price Dollars (each)	SD Code
782051 83012	84034	23.76	-



Touch-Up Paint
ANSI 61 gray enamel
12 oz. spray can

Barrier Bolt-On UPC Number	Barrier Bolt-On Catalog Number	Size (in.)	L (in.)	H (in.)	List Price Dollars (each)	SD Code
782051 40528	44-12BK* (S)	4.00x4.00	4.00	6.12	47.61	A
782051 40508	66-12BK* (S)	6.00x6.00	6.00	7.12	58.28	A
782051 40386	88-12BK* (S)	8.00x8.00	8.00	8.12	77.62	A
782051 07152	1010-12BK*	10.00x10.00	10.00	9.12	108.14	D
782051 11647	1212-12BK* (S)	12.00x12.00	12.00	10.12	133.98	B

* Not UL or CSA listed fitting.

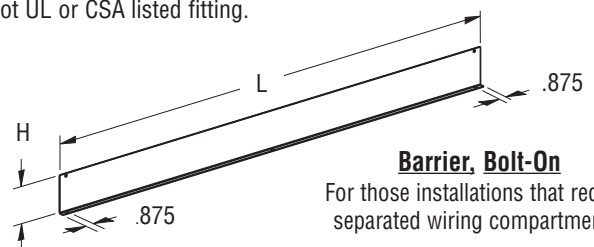

Barrier, Bolt-On

For those installations that require separated wiring compartments.

Other Cooper B-Line Product Lines

Strut Systems (Bolted Framing)
Cable Tray Systems
Electrical Enclosures
Electronic Enclosures
Pipe Hanger & Support Systems
Spring Steel Fasteners
Cable Runway & Relay Racks (CommData)
Meter Mounting & Distribution Equipment
Anchors

ENCRHCW-07

Cooper B-Line

509 West Monroe Street
Highland, IL 62249
Phone: 800-851-7415
Fax: 618-654-1917

www.cooperbline.com



SYSTEMS THAT MAKE SENSE

Cooper Industries, Ltd.
600 Travis, Ste. 5800
Houston, TX 77002-1001
Phone: 713-209-8400
www.cooperindustries.com