

Fittings For H14A, H15A, H16A and H17A

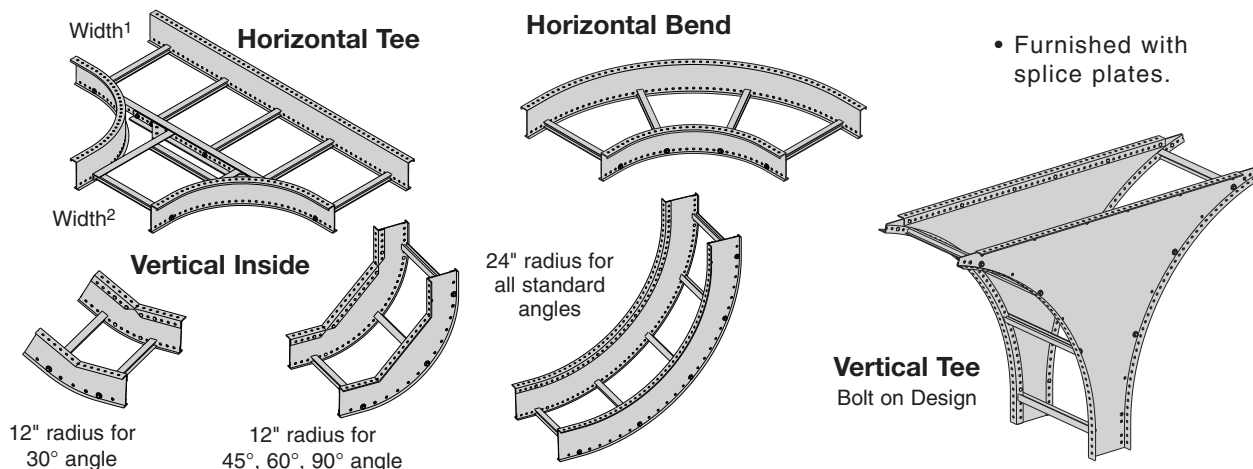

Fittings Part Numbering

Example: **H1 4 A R - 09 - 30 HB 12**

Series	Height	Material	Construction	Width	Angle	Type	Radius
● H1	● 4 = 4" ● 5 = 5" ● 6 = 6" ● 7 = 7"	Aluminum	Redi-Rail	● 06 = 6" ● 09 = 9" ● 12 = 12" ● 18 = 18" ● 24 = 24" ● 30 = 30" ● 36 = 36"	● 30 = 30° ● 45 = 45° ● 60 = 60° ● 90 = 90°	● HB = Horizontal Bend ● *HT = Horizontal Tee ● *HX = Horizontal Cross ● VI = Vertical Inside Bend ● VO = Vertical Outside Bend ● VT = Vertical Tee	● 12 = 12" ● 24 = 24"

*Angle not required on HT & HX

Horizontal Reducing / Expanding Tee or Cross Fittings Part Numbering

Example: **H1 4 A R - 09 - 12 - HT 12**

Series	Height	Material	Construction	Width ¹	Width ²	Type	Radius
● H1	● 4 = 4" ● 5 = 5" ● 6 = 6" ● 7 = 7"	Aluminum	Redi-Rail	06 = 6" 09 = 9" 12 = 12" 18 = 18" 24 = 24" 30 = 30" 36 = 36"	06 = 6" 09 = 9" 12 = 12" 18 = 18" 24 = 24" 30 = 30" 36 = 36"	● HT = Horizontal Tee ● HX = Horizontal Cross	● 12 = 12" ● 24 = 24"

For aluminum 4", 5", 6", 7" vented or non-ventilated bottom add 04 or SB as shown below.

Prefix
H15AR04 - 24 - 90HB24
Vented Bottom

Prefix
H15ARSB - 24 - 90HB24
Non-Ventilated Bottom

For stainless steel rung attachment hardware on all aluminum straight sections and fittings add SS as shown below.

Prefix
H15AR04 - 24 - 90HB24SS
Stainless Steel

- Green = Fastest shipped items
- Black = Normal lead-time items
- Red = Normally long lead-time items

Redi-Rail™ - Fittings

Horizontal Bends 90° 60° 45° 30° (HB)

1 pair splice plates with hardware included.

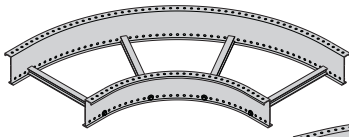

90° Horizontal Bend

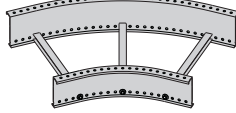

45° Horizontal Bend

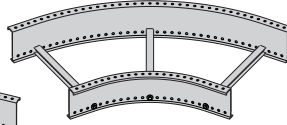

60° Horizontal Bend

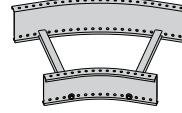

30° Horizontal Bend

Bottoms manufactured:
 Ladder = 9" Rung Spacing
 VT & 04 = 4" Rung Spacing
 ST & SB = Flat sheet over
 12" Rung Spacing

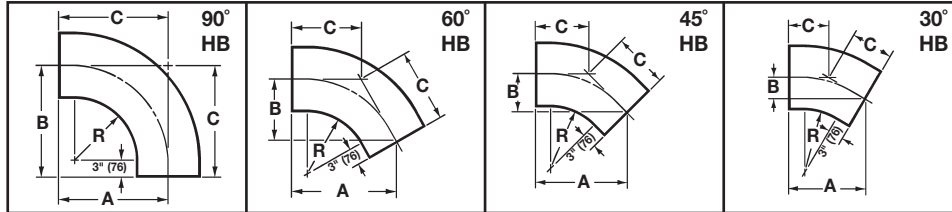

Bend Radius R	Tray Width	90° Horizontal Bend Dimensions						60° Horizontal Bend Dimensions							
		Catalog No.	A		B		C		Catalog No.	A		B		C	
in. (mm)	in. (mm)		in.	(mm)	in.	(mm)	in.	(mm)		in.	(mm)	in.	(mm)	in.	(mm)
12	305	(Pre)-06-90HB12	18 ¹ / ₁₆	459	18 ¹ / ₁₆	459	18 ¹ / ₁₆	459	(Pre)-06-60HB12	17 ⁹ / ₁₆	445	10 ¹ / ₈	258	11 ¹ / ₁₆	297
		(Pre)-09-90HB12	19 ⁹ / ₁₆	497	19 ⁹ / ₁₆	497	19 ⁹ / ₁₆	497	(Pre)-09-60HB12	18 ¹³ / ₁₆	478	10 ⁷ / ₈	277	12 ⁹⁸ / ₁₆	319
		(Pre)-12-90HB12	21 ¹ / ₁₆	535	21 ¹ / ₁₆	535	21 ¹ / ₁₆	535	(Pre)-12-60HB12	20 ¹ / ₈	511	11 ⁵ / ₈	296	13 ⁷ / ₁₆	341
		(Pre)-18-90HB12	24 ¹ / ₁₆	611	24 ¹ / ₁₆	611	24 ¹ / ₁₆	611	(Pre)-18-60HB12	22 ¹³ / ₄	577	13 ¹ / ₈	334	15 ³ / ₁₆	385
		(Pre)-24-90HB12	27 ¹ / ₁₆	687	27 ¹ / ₁₆	687	27 ¹ / ₁₆	687	(Pre)-24-60HB12	25 ⁵ / ₁₆	643	14 ⁵ / ₈	372	16 ⁷ / ₈	429
		(Pre)-30-90HB12	30 ¹ / ₁₆	763	30 ¹ / ₁₆	763	30 ¹ / ₁₆	763	(Pre)-30-60HB12	27 ¹⁵ / ₁₆	709	16 ¹ / ₈	410	18 ⁵ / ₈	473
		(Pre)-36-90HB12	33 ¹ / ₁₆	840	33 ¹ / ₁₆	840	33 ¹ / ₁₆	840	(Pre)-36-60HB12	30 ¹ / ₂	775	17 ³ / ₈	448	20 ³ / ₈	517
24	609	(Pre)-06-90HB24	30 ¹ / ₁₆	763	30 ¹ / ₁₆	763	30 ¹ / ₁₆	763	(Pre)-06-60HB24	27 ¹⁵ / ₁₆	709	16 ¹ / ₈	410	18 ⁵ / ₈	473
		(Pre)-09-90HB24	31 ⁹ / ₁₆	802	31 ⁹ / ₁₆	802	31 ⁹ / ₁₆	802	(Pre)-09-60HB24	29 ¹ / ₄	742	16 ⁷ / ₈	429	19 ¹ / ₂	495
		(Pre)-12-90HB24	33 ¹ / ₁₆	840	33 ¹ / ₁₆	840	33 ¹ / ₁₆	840	(Pre)-12-60HB24	30 ¹ / ₂	775	17 ³ / ₈	448	20 ³ / ₈	517
		(Pre)-18-90HB24	36 ¹ / ₁₆	916	36 ¹ / ₁₆	916	36 ¹ / ₁₆	916	(Pre)-18-60HB24	33 ¹ / ₈	841	19 ¹ / ₈	486	22 ¹ / ₈	561
		(Pre)-24-90HB24	39 ¹ / ₁₆	992	39 ¹ / ₁₆	992	39 ¹ / ₁₆	992	(Pre)-24-60HB24	35 ³ / ₄	907	20 ⁵ / ₈	524	23 ¹³ / ₁₆	605
		(Pre)-30-90HB24	42 ¹ / ₁₆	1068	42 ¹ / ₁₆	1068	42 ¹ / ₁₆	1068	(Pre)-30-60HB24	38 ⁵ / ₁₆	973	22 ¹ / ₈	562	25 ⁹ / ₁₆	649
		(Pre)-36-90HB24	45 ¹ / ₁₆	1144	45 ¹ / ₁₆	1144	45 ¹ / ₁₆	1144	(Pre)-36-60HB24	40 ¹⁵ / ₁₆	1039	23 ⁵ / ₈	600	27 ⁵ / ₁₆	693
45° Horizontal Bend								30° Horizontal Bend							
12	305	(Pre)-06-45HB12	15 ³ / ₄	400	6 ¹ / ₂	165	9 ³ / ₁₆	233	(Pre)-06-30HB12	13 ¹ / ₈	334	3 ⁹ / ₁₆	90	7 ¹ / ₁₆	180
		(Pre)-09-45HB12	16 ¹³ / ₁₆	427	6 ¹⁵ / ₁₆	176	9 ¹³ / ₁₆	249	(Pre)-09-30HB12	13 ⁷ / ₈	353	3 ³ / ₄	95	7 ¹ / ₂	190
		(Pre)-12-45HB12	17 ⁷ / ₈	454	7 ³ / ₈	187	10 ⁷ / ₁₆	265	(Pre)-12-30HB12	14 ⁵ / ₈	372	3 ¹⁵ / ₁₆	100	7 ⁷ / ₈	200
		(Pre)-18-45HB12	20	508	8 ¹ / ₄	209	11 ¹¹ / ₁₆	296	(Pre)-18-30HB12	16 ¹ / ₈	410	4 ⁵ / ₁₆	110	8 ¹¹ / ₁₆	220
		(Pre)-24-45HB12	22 ¹ / ₁₆	560	9 ¹ / ₈	232	12 ¹⁵ / ₁₆	328	(Pre)-24-30HB12	17 ⁵ / ₈	448	4 ³ / ₄	120	9 ¹ / ₂	241
		(Pre)-30-45HB12	24 ³ / ₁₆	614	10	254	14 ¹³ / ₁₆	360	(Pre)-30-30HB12	19 ¹ / ₈	486	5 ¹ / ₈	131	10 ⁵ / ₁₆	261
		(Pre)-36-45HB12	26 ⁵ / ₁₆	668	10 ¹⁵ / ₁₆	278	15 ⁷ / ₁₆	392	(Pre)-36-30HB12	20 ⁵ / ₈	524	5 ⁹ / ₁₆	141	11 ¹ / ₁₆	282
24	609	(Pre)-06-45HB24	24 ³ / ₁₆	614	10	250	14 ³ / ₁₆	360	(Pre)-06-30HB24	19 ¹ / ₈	486	5 ¹ / ₈	131	10 ⁵ / ₁₆	261
		(Pre)-09-45HB24	25 ¹ / ₄	641	10 ¹ / ₂	267	14 ¹³ / ₁₆	376	(Pre)-09-30HB24	19 ⁷ / ₈	505	5 ⁵ / ₁₆	136	10 ¹¹ / ₁₆	271
		(Pre)-12-45HB24	26 ⁵ / ₁₆	668	10 ¹⁵ / ₁₆	278	15 ⁷ / ₁₆	392	(Pre)-12-30HB24	20 ⁵ / ₈	524	5 ⁹ / ₁₆	141	11 ¹ / ₁₆	282
		(Pre)-18-45HB24	28 ⁷ / ₁₆	722	11 ¹³ / ₁₆	300	16 ¹¹ / ₁₆	424	(Pre)-18-30HB24	22 ¹ / ₈	563	5 ¹⁵ / ₁₆	151	11 ⁷ / ₈	302
		(Pre)-24-45HB24	30 ⁹ / ₁₆	776	12 ¹ / ₁₆	322	17 ¹⁵ / ₁₆	456	(Pre)-24-30HB24	23 ⁵ / ₈	601	6 ³ / ₈	161	12 ¹¹ / ₁₆	322
		(Pre)-30-45HB24	32 ¹¹ / ₁₆	830	13 ⁹ / ₁₆	345	19 ¹ / ₈	486	(Pre)-30-30HB24	25 ¹ / ₈	639	6 ³ / ₄	171	13 ¹ / ₂	343
		(Pre)-36-45HB24	34 ¹³ / ₁₆	884	14 ⁷ / ₁₆	367	20 ³ / ₈	518	(Pre)-36-30HB24	26 ⁵ / ₈	677	7 ¹ / ₈	182	14 ⁵ / ₁₆	363

(Pre) See page 191 for catalog number prefix.

All dimensions in parentheses are millimeters unless otherwise specified.

Width dimensions are to inside wall. Manufacturing tolerances apply to all dimensions.

Horizontal Tee (HT)

2 pair splice plates with hardware included.

Bend Radius R		Tray Width W		Horizontal Tee Dimensions				
				Catalog No.	A		B	
in.	(mm)	in.	(mm)		in.	(mm)		
12	305	6	152	(Prefix)-06-HT12	18 ¹ / ₁₆	458	36 ³ / ₄	933
		9	228	(Prefix)-09-HT12	19 ⁹ / ₁₆	497	39 ⁷ / ₈	1013
		12	305	(Prefix)-12-HT12	18 ¹ / ₁₆	535	42 ¹ / ₄	1073
		18	457	(Prefix)-18-HT12	24 ¹ / ₁₆	611	48 ¹ / ₂	1232
		24	609	(Prefix)-24-HT12	27 ¹ / ₁₆	687	54 ¹³ / ₁₆	1392
		30	762	(Prefix)-30-HT12	30 ¹ / ₁₆	763	60 ¹ / ₄	1530
24	609	6	152	(Prefix)-06-HT24	30 ¹ / ₁₆	763	61 ¹ / ₁₆	1551
		9	228	(Prefix)-09-HT24	31 ⁹ / ₁₆	801	64 ¹ / ₄	1631
		12	305	(Prefix)-12-HT24	33 ¹ / ₁₆	839	66 ⁹ / ₁₆	1691
		18	457	(Prefix)-18-HT24	36 ¹ / ₁₆	916	72 ¹ / ₁₆	1830
		24	609	(Prefix)-24-HT24	39 ¹ / ₁₆	992	78 ³ / ₈	1991
		30	762	(Prefix)-30-HT24	42 ¹ / ₁₆	1068	84 ⁵ / ₈	2150
		36	914	(Prefix)-36-HT24	45 ¹ / ₁₆	1144	90 ¹⁵ / ₁₆	2310

(Prefix) See page 191 for catalog number prefix.

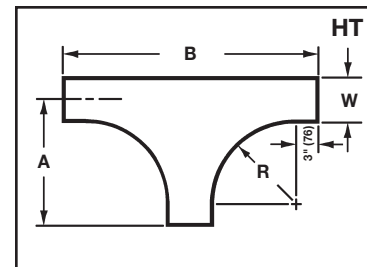
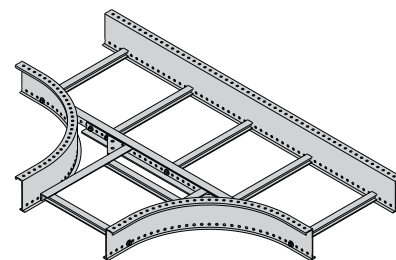

Horizontal Cross (HX)

3 pair splice plates with hardware included.

Bend Radius R		Tray Width W		Horizontal Cross Dimensions				
				Catalog No.	A		B	
in.	(mm)	in.	(mm)		in.	(mm)		
12	305	6	152	(Prefix)-06-HX12	18 ¹ / ₁₆	458	36 ³ / ₄	913
		9	228	(Prefix)-09-HX12	19 ⁹ / ₁₆	497	39 ⁷ / ₈	1013
		12	305	(Prefix)-12-HX12	21 ¹ / ₁₆	535	42 ¹ / ₄	1073
		18	457	(Prefix)-18-HX12	24 ¹ / ₁₆	611	48 ¹ / ₂	1232
		24	609	(Prefix)-24-HX12	27 ¹ / ₁₆	687	54 ¹³ / ₁₆	1392
		30	762	(Prefix)-30-HX12	30 ¹ / ₁₆	763	60 ¹ / ₄	1530
24	609	6	152	(Prefix)-06-HX24	30 ¹ / ₁₆	763	60 ¹ / ₁₆	1551
		9	228	(Prefix)-09-HX24	31 ⁹ / ₁₆	801	64 ¹ / ₄	1631
		12	305	(Prefix)-12-HX24	33 ¹ / ₁₆	839	66 ⁹ / ₁₆	1691
		18	457	(Prefix)-18-HX24	36 ¹ / ₁₆	916	72 ¹ / ₁₆	1830
		24	609	(Prefix)-24-HX24	39 ¹ / ₁₆	992	78 ³ / ₈	1991
		30	762	(Prefix)-30-HX24	42 ¹ / ₁₆	1068	84 ⁵ / ₈	2150
		36	914	(Prefix)-36-HX24	45 ¹ / ₁₆	1144	90 ¹⁵ / ₁₆	2310

(Prefix) See page 191 for catalog number prefix.

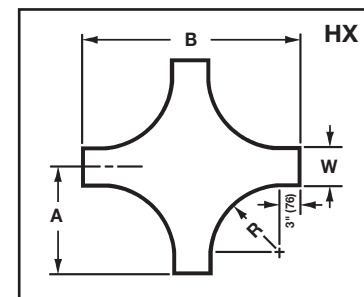
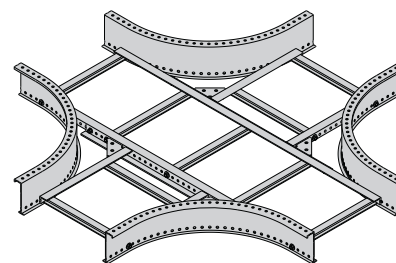

All dimensions in parentheses are millimeters unless otherwise specified.
Width dimensions are to inside wall. Manufacturing tolerances apply to all dimensions.

Redi-Rail™ - Fittings

Horizontal Reducing Tee (HT)

2 pair splice plates with hardware included.

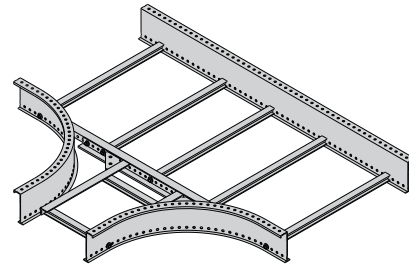

Prefix - 36 - 18 HT 24

Radius
Fitting
Width W_2
Width W_1

To complete catalog number, insert fitting prefix.

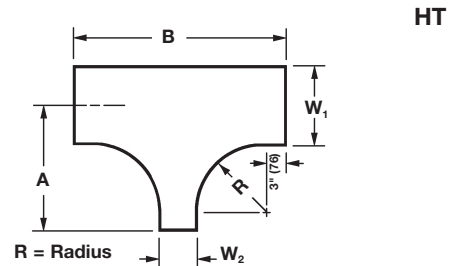

Tray Width				* Insert Radius (12 for 12" or 24 for 24") Catalog No.	12" Radius				24" Radius			
W1		W2			A		B		A		B	
in.	(mm)	in.	(mm)	in.	(mm)	in.	(mm)	in.	(mm)	in.	(mm)	
9	228	6	152	(Prefix)-09-06-HT*	19 ⁹ / ₁₆	497	36 ³ / ₄	933	31 ⁹ / ₁₆	801	61 ¹ / ₁₆	1551
12	305	6	152	(Prefix)-12-06-HT*	21 ¹ / ₁₆	535	36 ³ / ₄	933	33 ¹ / ₁₆	839	61 ¹ / ₁₆	1551
		9	228	(Prefix)-12-09-HT*	21 ¹ / ₁₆	535	39 ⁷ / ₈	1013	33 ¹ / ₁₆	839	64 ¹ / ₄	1631
18	475	6	152	(Prefix)-18-06-HT*	24 ¹ / ₁₆	611	36 ³ / ₄	933	36 ¹ / ₁₆	916	61 ¹ / ₁₆	1551
		9	228	(Prefix)-18-09-HT*	24 ¹ / ₁₆	611	39 ⁷ / ₈	1013	36 ¹ / ₁₆	916	64 ¹ / ₄	1631
		12	305	(Prefix)-18-12-HT*	24 ¹ / ₁₆	611	42 ¹ / ₄	1073	36 ¹ / ₁₆	916	66 ⁹ / ₁₆	1691
24	609	6	152	(Prefix)-24-06-HT*	27 ¹ / ₁₆	687	36 ³ / ₄	933	39 ¹ / ₁₆	992	61 ¹ / ₁₆	1551
		9	228	(Prefix)-24-09-HT*	27 ¹ / ₁₆	687	39 ⁷ / ₈	1013	39 ¹ / ₁₆	992	64 ¹ / ₄	1631
		12	305	(Prefix)-24-12-HT*	27 ¹ / ₁₆	687	42 ¹ / ₄	1073	39 ¹ / ₁₆	992	66 ⁹ / ₁₆	1691
		18	457	(Prefix)-24-18-HT*	27 ¹ / ₁₆	687	48 ¹ / ₂	1232	39 ¹ / ₁₆	992	72 ¹ / ₁₆	1830
30	762	6	152	(Prefix)-30-06-HT*	30 ¹ / ₁₆	763	36 ³ / ₄	933	42 ¹ / ₁₆	1068	61 ¹ / ₁₆	1551
		9	228	(Prefix)-30-09-HT*	30 ¹ / ₁₆	763	39 ⁷ / ₈	1013	42 ¹ / ₁₆	1068	64 ¹ / ₄	1631
		12	305	(Prefix)-30-12-HT*	30 ¹ / ₁₆	763	42 ¹ / ₄	1073	42 ¹ / ₁₆	1068	66 ⁹ / ₁₆	1691
		18	457	(Prefix)-30-18-HT*	30 ¹ / ₁₆	763	48 ¹ / ₂	1232	42 ¹ / ₁₆	1068	72 ¹ / ₁₆	1830
		24	609	(Prefix)-30-24-HT*	30 ¹ / ₁₆	763	54 ¹³ / ₁₆	1392	42 ¹ / ₁₆	1068	78 ³ / ₈	1991
36	914	6	152	(Prefix)-36-06-HT*	33 ¹ / ₁₆	839	36 ³ / ₄	933	45 ¹ / ₁₆	1144	61 ¹ / ₁₆	1551
		9	228	(Prefix)-36-09-HT*	33 ¹ / ₁₆	839	39 ⁷ / ₈	1013	45 ¹ / ₁₆	1144	64 ¹ / ₄	1631
		12	305	(Prefix)-36-12-HT*	33 ¹ / ₁₆	839	42 ¹ / ₄	1073	45 ¹ / ₁₆	1144	66 ⁹ / ₁₆	1691
		18	457	(Prefix)-36-18-HT*	33 ¹ / ₁₆	839	48 ¹ / ₂	1232	45 ¹ / ₁₆	1144	72 ¹ / ₁₆	1830
		24	609	(Prefix)-36-24-HT*	33 ¹ / ₁₆	839	54 ¹³ / ₁₆	1392	45 ¹ / ₁₆	1144	78 ³ / ₈	1991
		30	762	(Prefix)-36-30-HT*	33 ¹ / ₁₆	839	60 ¹ / ₄	1532	45 ¹ / ₁₆	1144	84 ⁵ / ₈	2150

(Prefix) See page 191 for catalog number prefix.

All dimensions in parentheses are millimeters unless otherwise specified.

Width dimensions are to inside wall.

Manufacturing tolerances apply to all dimensions.

Horizontal Expanding Tee (HT)

2 pair splice plates with hardware included.

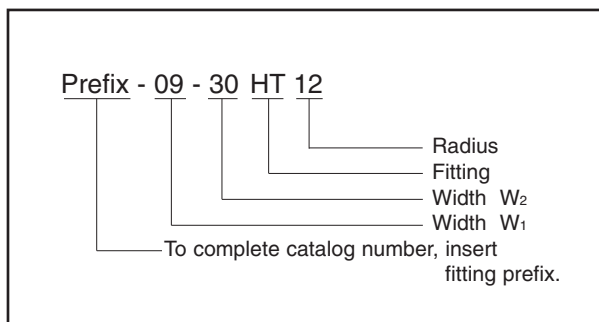
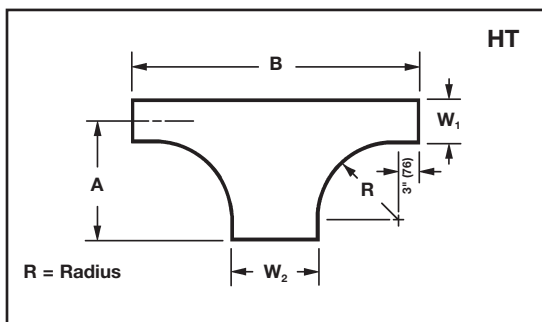
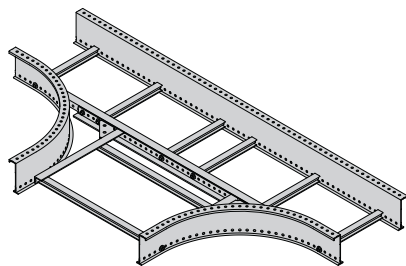

Tray Width		*Insert Radius (12 for 12", 24 for 24") Catalog No.		12" Radius				24" Radius				
W ₁ in. (mm)	W ₂ in. (mm)			A in. (mm)		B in. (mm)		A in. (mm)		B in. (mm)		
6	152	9	228	(Prefix)-06-09-HT*	18 ¹ / ₁₆	458	39 ⁷ / ₈	1013	30 ¹ / ₁₆	763	64 ¹ / ₄	1631
		12	305	(Prefix)-06-12-HT*	18 ¹ / ₁₆	458	42 ¹ / ₄	1073	30 ¹ / ₁₆	763	66 ⁹ / ₁₆	1691
		18	457	(Prefix)-06-18-HT*	18 ¹ / ₁₆	458	48 ¹ / ₂	1232	30 ¹ / ₁₆	763	72 ¹ / ₁₆	1830
		24	609	(Prefix)-06-24-HT*	18 ¹ / ₁₆	458	54 ¹³ / ₁₆	1392	30 ¹ / ₁₆	763	78 ³ / ₈	1991
		30	762	(Prefix)-06-30-HT*	18 ¹ / ₁₆	458	60 ¹ / ₄	1532	30 ¹ / ₁₆	763	84 ⁵ / ₈	2150
		36	914	(Prefix)-06-36-HT*	18 ¹ / ₁₆	458	66 ⁹ / ₁₆	1691	30 ¹ / ₁₆	763	90 ¹⁵ / ₁₆	2310
9	228	12	305	(Prefix)-09-12-HT*	19 ⁹ / ₁₆	497	42 ¹ / ₄	1073	31 ⁹ / ₁₆	801	66 ⁹ / ₁₆	1691
		18	457	(Prefix)-09-18-HT*	19 ⁹ / ₁₆	497	48 ¹ / ₂	1232	31 ⁹ / ₁₆	801	72 ¹ / ₁₆	1830
		24	609	(Prefix)-09-24-HT*	19 ⁹ / ₁₆	497	54 ¹³ / ₁₆	1392	31 ⁹ / ₁₆	801	78 ³ / ₈	1991
		30	762	(Prefix)-09-30-HT*	19 ⁹ / ₁₆	497	60 ¹ / ₄	1532	31 ⁹ / ₁₆	801	84 ⁵ / ₈	2150
		36	914	(Prefix)-09-36-HT*	19 ⁹ / ₁₆	497	66 ⁹ / ₁₆	1691	31 ⁹ / ₁₆	801	90 ¹⁵ / ₁₆	2310
12	305	18	457	(Prefix)-12-18-HT*	21 ¹ / ₁₆	535	48 ¹ / ₂	1232	33 ¹ / ₁₆	839	72 ¹ / ₁₆	1830
		24	609	(Prefix)-12-24-HT*	21 ¹ / ₁₆	535	54 ¹³ / ₁₆	1392	33 ¹ / ₁₆	839	78 ³ / ₈	1991
		30	762	(Prefix)-12-30-HT*	21 ¹ / ₁₆	535	60 ¹ / ₄	1532	33 ¹ / ₁₆	839	84 ⁵ / ₈	2150
		36	914	(Prefix)-12-36-HT*	21 ¹ / ₁₆	535	66 ⁹ / ₁₆	1691	33 ¹ / ₁₆	839	90 ¹⁵ / ₁₆	2310
18	457	24	609	(Prefix)-18-24-HT*	24 ¹ / ₁₆	611	54 ¹³ / ₁₆	1392	36 ¹ / ₁₆	916	78 ³ / ₈	1991
		30	762	(Prefix)-18-30-HT*	24 ¹ / ₁₆	611	60 ¹ / ₄	1532	36 ¹ / ₁₆	916	84 ⁵ / ₈	2150
		36	914	(Prefix)-18-36-HT*	24 ¹ / ₁₆	611	66 ⁹ / ₁₆	1691	36 ¹ / ₁₆	916	90 ¹⁵ / ₁₆	2310
24	609	30	762	(Prefix)-24-30-HT*	27 ¹ / ₁₆	687	60 ¹ / ₄	1532	39 ¹ / ₁₆	992	84 ⁵ / ₈	2150
		36	914	(Prefix)-24-36-HT*	27 ¹ / ₁₆	687	66 ⁹ / ₁₆	1691	39 ¹ / ₁₆	992	90 ¹⁵ / ₁₆	2310
30	762	36	914	(Prefix)-30-36-HT*	30 ¹ / ₁₆	763	66 ⁹ / ₁₆	1691	42 ¹ / ₁₆	1068	90 ¹⁵ / ₁₆	2310

(Prefix) See page 191 for catalog number prefix.

All dimensions in parentheses are millimeters unless otherwise specified.

Width dimensions are to inside wall.

Manufacturing tolerances apply to all dimensions.

Redi-Rail™ - Fittings

Horizontal Expanding/Reducing Cross (HX)

3 pair splice plates with hardware included.

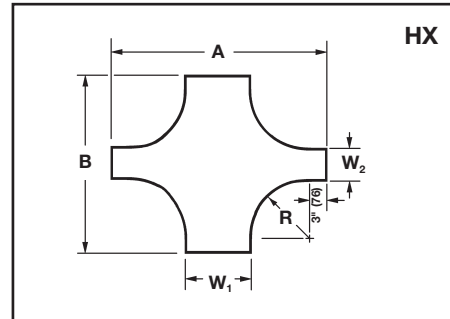
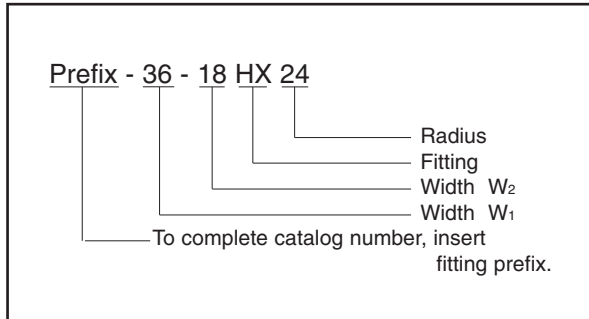
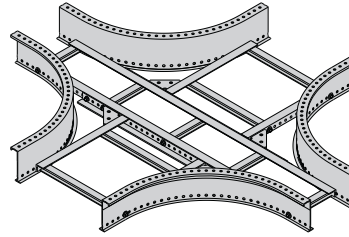

Redi-Rail

Tray Width		*Insert Radius (12 for 12", 24 for 24") Catalog No.		12" Radius				24" Radius				
W ₁ in. (mm)	W ₂ in. (mm)			A		B		A		B		
				in. (mm)	in. (mm)	in. (mm)	in. (mm)	in. (mm)	in. (mm)	in. (mm)	in. (mm)	
6	152	9	228	(Prefix)-09-09-HX*	36 ³ / ₄	933	39 ⁷ / ₈	1013	60 ¹ / ₈	1526	64 ¹ / ₄	1631
		12	305	(Prefix)-12-06-HX*	36 ³ / ₄	933	42 ¹ / ₄	1073	60 ¹ / ₈	1526	66 ⁹ / ₁₆	1691
		18	457	(Prefix)-18-06-HX*	36 ³ / ₄	933	48 ¹ / ₂	1232	60 ¹ / ₈	1526	72 ¹ / ₁₆	1830
		24	609	(Prefix)-24-06-HX*	36 ³ / ₄	933	54 ¹³ / ₁₆	1392	60 ¹ / ₈	1526	78 ³ / ₈	1991
		30	762	(Prefix)-30-06-HX*	36 ³ / ₄	933	60 ¹ / ₄	1532	60 ¹ / ₈	1526	84 ⁵ / ₈	2150
		36	914	(Prefix)-36-06-HX*	36 ³ / ₄	933	66 ⁹ / ₁₆	1691	60 ¹ / ₈	1526	90 ¹⁵ / ₁₆	2310
9	228	12	305	(Prefix)-12-09-HX*	39 ¹ / ₈	993	42 ¹ / ₄	1073	63 ¹ / ₈	1603	66 ⁹ / ₁₆	1691
		18	457	(Prefix)-18-09-HX*	39 ¹ / ₈	993	48 ¹ / ₂	1232	63 ¹ / ₈	1603	72 ¹ / ₁₆	1830
		24	609	(Prefix)-24-09-HX*	39 ¹ / ₈	993	54 ¹³ / ₁₆	1392	63 ¹ / ₈	1603	78 ³ / ₈	1991
		30	762	(Prefix)-30-09-HX*	39 ¹ / ₈	993	60 ¹ / ₄	1532	63 ¹ / ₈	1603	84 ⁵ / ₈	2150
		36	914	(Prefix)-36-09-HX*	39 ¹ / ₈	993	66 ⁹ / ₁₆	1691	63 ¹ / ₈	1603	90 ¹⁵ / ₁₆	2310
12	305	18	457	(Prefix)-18-11-HX*	42 ¹ / ₈	1069	48 ¹ / ₂	1232	63 ¹ / ₈	1679	72 ¹ / ₁₆	1830
		24	609	(Prefix)-24-12-HX*	42 ¹ / ₈	1069	54 ¹³ / ₁₆	1392	63 ¹ / ₈	1679	78 ³ / ₈	1991
		30	762	(Prefix)-30-12-HX*	42 ¹ / ₈	1069	60 ¹ / ₄	1532	63 ¹ / ₈	1679	84 ⁵ / ₈	2150
		36	914	(Prefix)-36-12-HX*	42 ¹ / ₈	1069	66 ⁹ / ₁₆	1691	63 ¹ / ₈	1679	90 ¹⁵ / ₁₆	2310
18	457	24	609	(Prefix)-24-18-HX*	42 ¹ / ₈	1069	54 ¹³ / ₁₆	1392	72 ¹ / ₈	1831	78 ³ / ₈	1991
		30	762	(Prefix)-30-18-HX*	42 ¹ / ₈	1069	60 ¹ / ₄	1532	72 ¹ / ₈	1831	84 ⁵ / ₈	2150
		36	914	(Prefix)-36-18-HX*	42 ¹ / ₈	1069	66 ⁹ / ₁₆	1691	72 ¹ / ₈	1831	90 ¹⁵ / ₁₆	2310
24	609	30	762	(Prefix)-30-24-HX*	54 ¹ / ₈	1374	60 ¹ / ₄	1532	78 ¹ / ₈	1984	84 ⁵ / ₈	2150
		36	914	(Prefix)-36-24-HX*	54 ¹ / ₈	1374	66 ⁹ / ₁₆	1691	78 ¹ / ₈	1984	90 ¹⁵ / ₁₆	2310
30	762	36	914	(Prefix)-36-30-HX*	60 ¹ / ₈	1526	66 ⁹ / ₁₆	1691	84 ¹ / ₈	2136	90 ¹⁵ / ₁₆	2310

(Prefix) See page 191 for catalog number prefix.

All dimensions in parentheses are millimeters unless otherwise specified.

Width dimensions are to inside wall.

Manufacturing tolerances apply to all dimensions.

Vertical Bend 90° (VO, VI)

1 pair splice plates with hardware included.

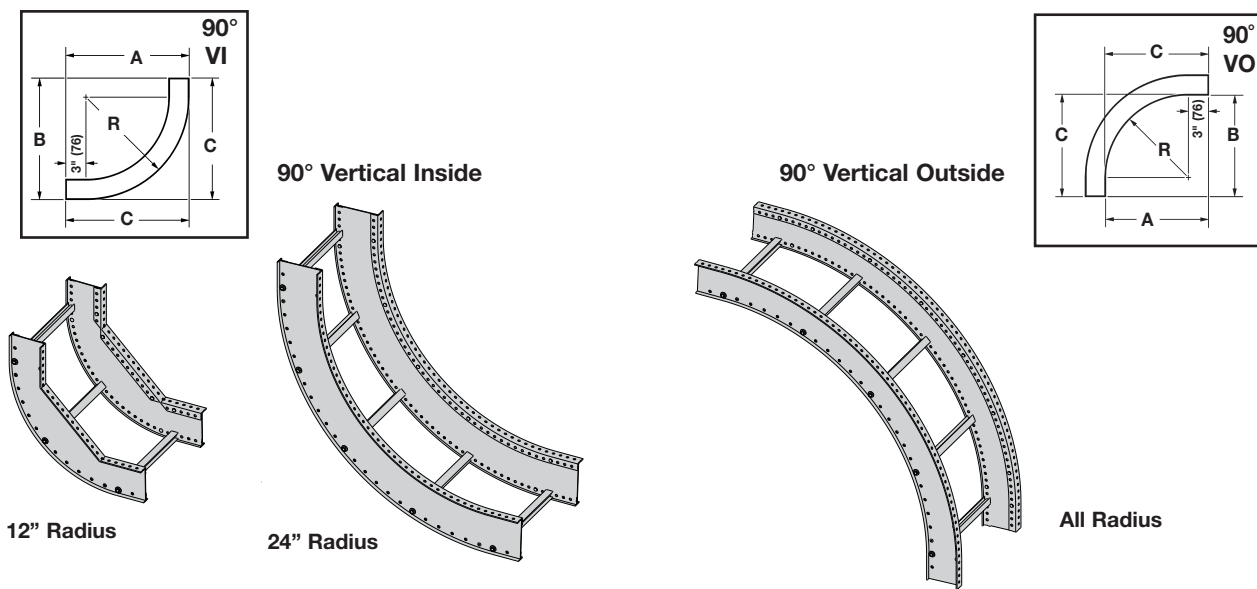

90°		Vertical Inside (VI) Bend					Vertical Outside (VO) Bend				
Bend Radius R	Width	Catalog No.	VI Dimensions			Catalog No.	VO Dimensions				
			A	B	C		A	B	C		
12	305	(Pre)-06-90VI12	15 ¹ / ₈ " (385)	15 ¹ / ₈ " (385)	15 ¹ / ₈ " (385)	(Pre)-06-90VO12	14 ¹⁵ / ₁₆ " (380)	14 ¹⁵ / ₁₆ " (380)	14 ¹⁵ / ₁₆ " (380)		
		(Pre)-09-90VI12				(Pre)-09-90VO12					
		(Pre)-12-90VI12				(Pre)-12-90VO12					
		(Pre)-18-90VI12				(Pre)-18-90VO12					
		(Pre)-24-90VI12				(Pre)-24-90VO12					
		(Pre)-30-90VI12				(Pre)-30-90VO12					
		(Pre)-36-90VI12				(Pre)-36-90VO12					
24	609	(Pre)-06-90VI24	27 ¹ / ₈ " (690)	27 ¹ / ₈ " (690)	27 ¹ / ₈ " (690)	(Pre)-06-90VO24	26 ¹⁵ / ₁₆ " (684)	26 ¹⁵ / ₁₆ " (684)	26 ¹⁵ / ₁₆ " (684)		
		(Pre)-09-90VI24				(Pre)-09-90VO24					
		(Pre)-12-90VI24				(Pre)-12-90VO24					
		(Pre)-18-90VI24				(Pre)-18-90VO24					
		(Pre)-24-90VI24				(Pre)-24-90VO24					
		(Pre)-30-90VI24				(Pre)-30-90VO24					
		(Pre)-36-90VI24				(Pre)-36-90VO24					

(Pre) See page 191 for catalog number prefix.
 All dimensions in parentheses are millimeters unless otherwise specified.
 Manufacturing tolerances apply to all dimensions.

Redi-Rail™ - Fittings

Vertical Bend 60° (VO, VI)

1 pair splice plates with hardware included.

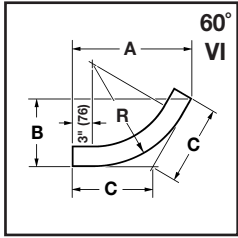

60° Vertical Inside

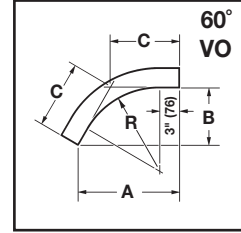

60° Vertical Outside

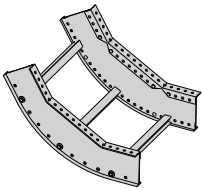

12" Radius

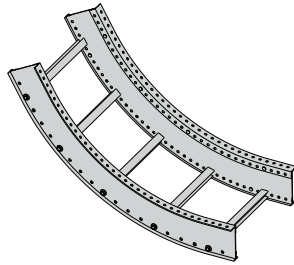

24" Radius

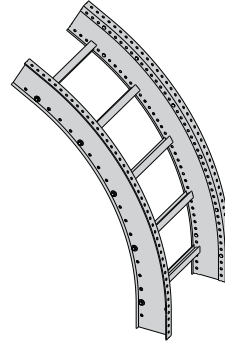

All Radius

60°		Vertical Inside (VI) Bend				Vertical Outside (VO) Bend					
Bend Radius R	Width	Catalog No.	VI Dimensions			Catalog No.	VO Dimensions				
			A	B	C		A	B	C		
in.	(mm)	in.	(mm)								
12	305	6	152	(Pre)-06-60VI12	15 ¹ / ₁₆ " (382)	8 ¹¹ / ₁₆ " (221)	10 ¹ / ₁₆ " (255)	(Pre)-06-60VO12	14 ⁷ / ₈ " (378)	8 ³ / ₄ " (222)	9 ¹⁵ / ₁₆ " (252)
		9	228	(Pre)-09-60VI12				(Pre)-09-60VO12			
		12	305	(Pre)-12-60VI12				(Pre)-12-60VO12			
		18	457	(Pre)-18-60VI12				(Pre)-18-60VO12			
		24	609	(Pre)-24-60VI12				(Pre)-24-60VO12			
		30	762	(Pre)-30-60VI12				(Pre)-30-60VO12			
24	609	6	152	(Pre)-06-60VI24	25 ⁷ / ₁₆ " (646)	14 ¹¹ / ₁₆ " (373)	16 ¹⁵ / ₁₆ " (431)	(Pre)-06-60VO24	25 ¹ / ₄ " (642)	14 ³ / ₄ " (375)	16 ⁷ / ₈ " (428)
		9	228	(Pre)-09-60VI24				(Pre)-09-60VO24			
		12	305	(Pre)-12-60VI24				(Pre)-12-60VO24			
		18	457	(Pre)-18-60VI24				(Pre)-18-60VO24			
		24	609	(Pre)-24-60VI24				(Pre)-24-60VO24			
		30	762	(Pre)-30-60VI24				(Pre)-30-60VO24			
		36	914	(Pre)-36-60VI24				(Pre)-36-60VO24			

(Pre) See page 191 for catalog number prefix.
 All dimensions in parentheses are millimeters unless otherwise specified.
 Manufacturing tolerances apply to all dimensions.

Vertical Bend 45° (VO, VI)

1 pair splice plates with hardware included.

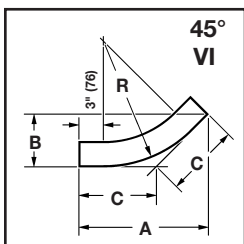

45° Vertical Inside

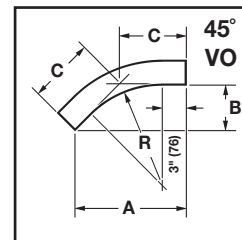

45° Vertical Outside

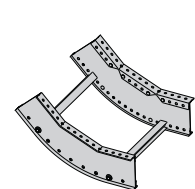

12" Radius

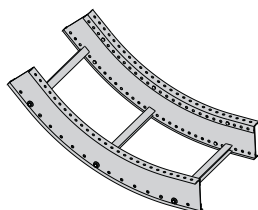

24" Radius

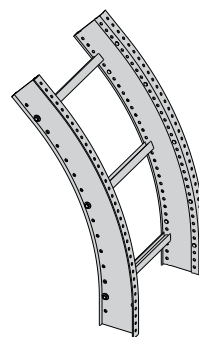

All Radius

45°		Vertical Inside (VI) Bend				Vertical Outside (VO) Bend					
Bend Radius R in. (mm)	Width		Catalog No.	VI Dimensions			Catalog No.	VO Dimensions			
	in.	(mm)		A	B	C		A	B	C	
12	305	6	152	(Pre)-06-45VI12	13 ³ / ₄ " (349)	5 ¹¹ / ₁₆ " (145)	8 ¹ / ₁₆ " (205)	(Pre)-06-45VO12	13 ⁵ / ₈ " (346)	5 ³ / ₄ " (146)	8" (203)
		9	228	(Pre)-09-45VI12				(Pre)-09-45VO12			
		12	305	(Pre)-12-45VI12				(Pre)-12-45VO12			
		18	457	(Pre)-18-45VI12				(Pre)-18-45VO12			
		24	609	(Pre)-24-45VI12				(Pre)-24-45VO12			
		30	762	(Pre)-30-45VI12				(Pre)-30-45VO12			
24	609	6	152	(Pre)-06-45VI24	22 ¹ / ₄ " (565)	9 ³ / ₁₆ " (234)	13" (331)	(Pre)-06-45VO24	19 ³ / ₁₆ " (487)	9 ¹ / ₄ " (235)	12 ¹⁵ / ₁₆ " (329)
		9	228	(Pre)-09-45VI24				(Pre)-09-45VO24			
		12	305	(Pre)-12-45VI24				(Pre)-12-45VO24			
		18	457	(Pre)-18-45VI24				(Pre)-18-45VO24			
		24	609	(Pre)-24-45VI24				(Pre)-24-45VO24			
		30	762	(Pre)-30-45VI24				(Pre)-30-45VO24			
		36	914	(Pre)-36-45VI24				(Pre)-36-45VO24			

(Pre) See page 191 for catalog number prefix.
 All dimensions in parentheses are millimeters unless otherwise specified.
 Manufacturing tolerances apply to all dimensions.

Redi-Rail™ - Fittings

Vertical Bend 30° (VO, VI)

1 pair splice plates with hardware included.

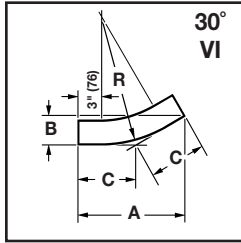

45° Vertical Inside

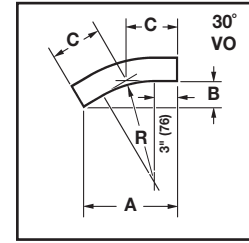

45° Vertical Outside

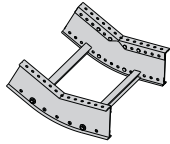

12" Radius

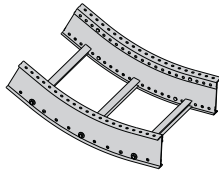

24" Radius

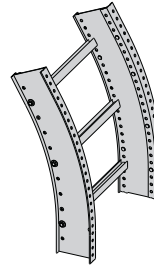

All Radius

30°		Vertical Inside (VI) Bend				Vertical Outside (VO) Bend			
Bend Radius R	Width	Catalog No.	VI Dimensions			Catalog No.	VO Dimensions		
			A	B	C		A	B	C
12	305	(Pre)-06-45VI12	11 ³ / ₄ " (298)	3 ¹ / ₈ " (80)	6 ⁵ / ₁₆ " (160)	(Pre)-06-45VO12	11 ⁵ / ₈ " (296)	3 ³ / ₁₆ " (81)	6 ³ / ₈ " (162)
		(Pre)-09-45VI12				(Pre)-09-45VO12			
		(Pre)-12-45VI12				(Pre)-12-45VO12			
		(Pre)-18-45VI12				(Pre)-18-45VO12			
		(Pre)-24-45VI12				(Pre)-24-45VO12			
		(Pre)-30-45VI12				(Pre)-30-45VO12			
24	609	(Pre)-06-45VI24	17 ³ / ₄ " (451)	4 ³ / ₄ " (121)	9 ¹ / ₂ " (241)	(Pre)-06-45VO24	17 ⁵ / ₈ " (448)	4 ³ / ₄ " (121)	9 ⁹ / ₁₆ " (243)
		(Pre)-09-45VI24				(Pre)-09-45VO24			
		(Pre)-12-45VI24				(Pre)-12-45VO24			
		(Pre)-18-45VI24				(Pre)-18-45VO24			
		(Pre)-24-45VI24				(Pre)-24-45VO24			
		(Pre)-30-45VI24				(Pre)-30-45VO24			
(Pre)-36-45VI24	(Pre)-36-45VO24								

(Pre) See page 191 for catalog number prefix.

All dimensions in parentheses are millimeters unless otherwise specified.

Manufacturing tolerances apply to all dimensions.

Vertical Tee Up/Down (VTU/VT)

2 pair splice plates with hardware included.

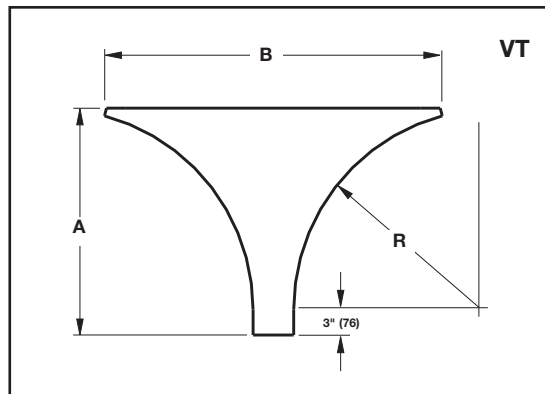
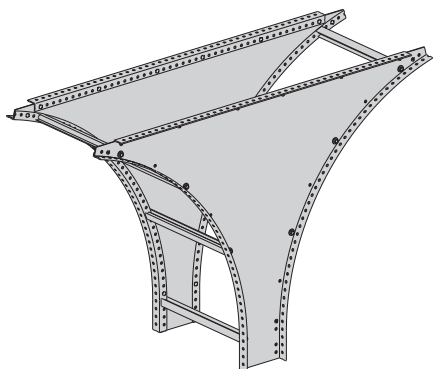

Bend Radius R	Tray Width		Reversible Up or Down Catalog No.	Side Rail Height "H"									
				4" - 7"		4"		5"		6"		7"	
				A		B		B		B		B	
in.	in. (mm)		in.	(mm)	in.	(mm)	in.	(mm)	in.	(mm)	in.	(mm)	
12" (305)	6	152	(Prefix)-06-VT12 (Prefix)-09-VT12 (Prefix)-12-VT12 (Prefix)-18-VT12 (Prefix)-24-VT12 (Prefix)-30-VT12	11 ³ / ₁₆	284	17 ¹ / ₁₆	433	18 ¹ / ₁₆	459	19 ¹ / ₁₆	484	20 ¹ / ₁₆	510
	9	228											
	12	305											
	18	457											
	24	609											
24" (609)	6	152	(Prefix)-06-VT24 (Prefix)-09-VT24 (Prefix)-12-VT24 (Prefix)-18-VT24 (Prefix)-24-VT24 (Prefix)-30-VT24	27 ¹ / ₁₆	687	39 ¹ / ₄	997	40 ¹ / ₄	1022	41 ¹ / ₄	1048	42 ¹ / ₄	1073
	9	228											
	12	305											
	18	457											
	24	609											
36" (914)	6	152	(Prefix)-06-VT36 (Prefix)-09-VT36 (Prefix)-12-VT36 (Prefix)-18-VT36 (Prefix)-24-VT36 (Prefix)-30-VT36	39 ¹¹ / ₁₆	992	58 ³ / ₈	1483	59 ³ / ₈	1508	60 ³ / ₈	1533	61 ³ / ₈	1559
	9	228											
	12	305											
	18	457											
	24	609											

(Prefix) See page 191 for catalog number prefix.
 All dimensions in parentheses are millimeters unless otherwise specified.
 Manufacturing tolerances apply to all dimensions.