

Miscellaneous Fittings

B214 R&L REEL RACK SUPPORT FOR 1 1/4" (32) PIPE

- Standard finishes: ZN, GRN
- Wt./C 200 Lbs. (90.7 kg)

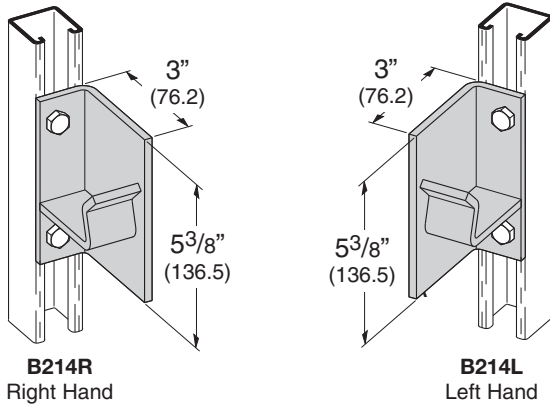

B514 R&L REEL RACK SUPPORT FOR 2" (50) PIPE

- Standard finishes: ZN, GRN
- Wt./C 246 Lbs. (111.6 kg)

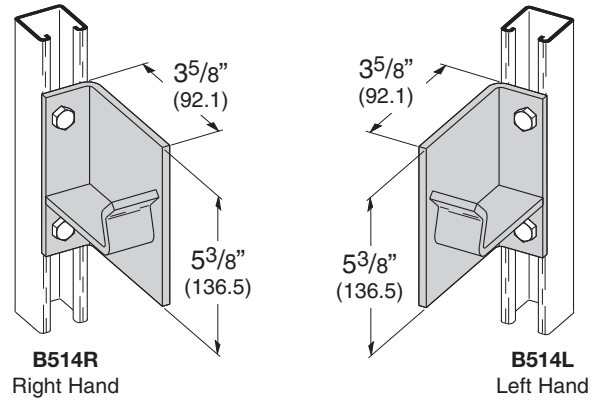

B475 DOUBLE REEL RACK SUPPORT ON SINGLE CHANNEL FOR 1 1/4" (32) PIPE

- Standard finishes: ZN, GRN
- Wt./C 326 Lbs. (147.9 kg)

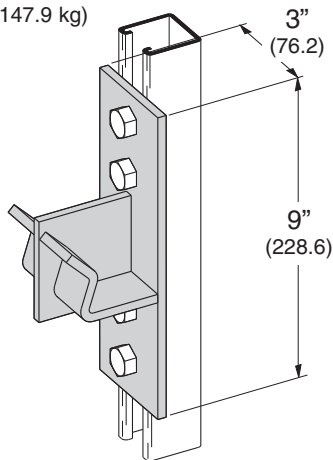

B473 DOUBLE REEL RACK SUPPORT ON SINGLE CHANNEL FOR 2" (50) PIPE

- Standard finishes: ZN, GRN
- Wt./C 351 Lbs. (159.2 kg)

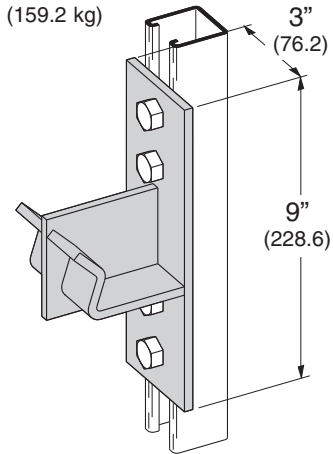

B474 DOUBLE REEL RACK CHANNEL FOR 1 1/4" (32) PIPE

- Standard finishes: ZN, GRN
- Wt./C 257 Lbs. (116.6 kg)

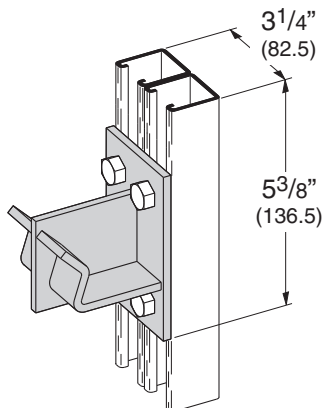

B472 DOUBLE REEL RACK SUPPORT ON DOUBLE CHANNEL FOR 2" (50) PIPE

- Standard finishes: ZN, GRN
- Wt./C 299 Lbs. (135.6 kg)

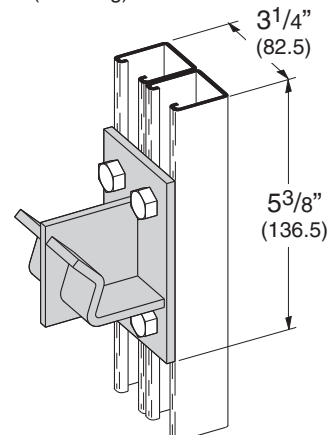

Reference page 72 for general fitting and standard finish specifications.

B664 DOUBLE PIPE SUPPORT FOR 1 1/4" (32) PIPE

- Standard finishes: ZN, GRN
- Wt./C 154 Lbs. (69.8 kg)

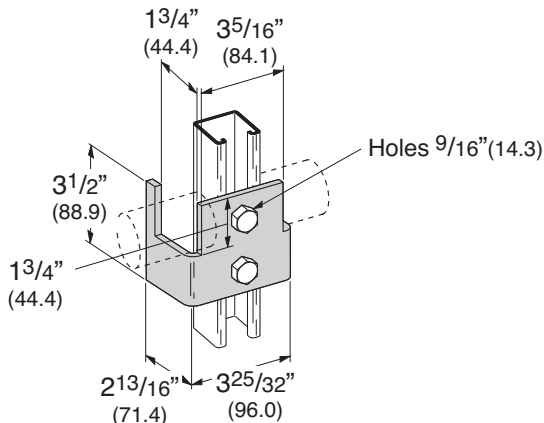

B438 PIPE SUPPORT BRACKET

- Standard finishes: ZN, GRN
- Material: ASTM A36
- Wt./C 132 Lbs. (59.9 kg)

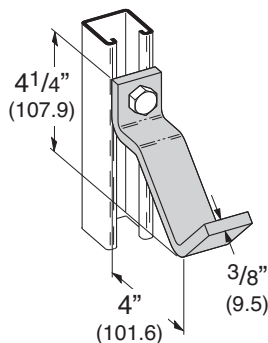

B439 PIPE SUPPORT BRACKET

- Standard finishes: ZN, GRN
- Wt./C 88 Lbs. (39.9 kg)

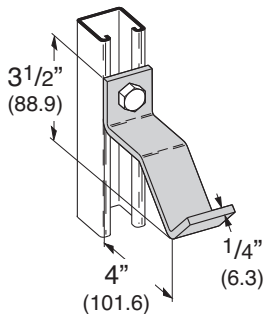

B411 SERIES LADDER RUNGS

- Standard finishes: ZN, GRN

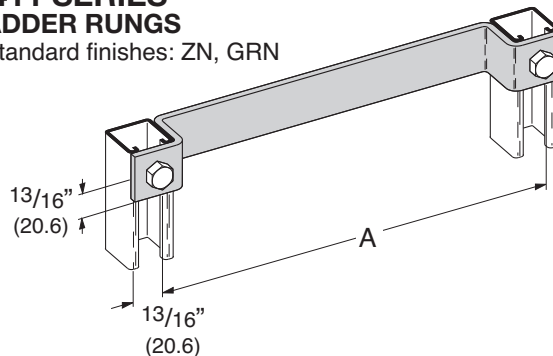

Part No.	A	(A)	Wt./C	
			Lbs.	kg
B411-12	12"	(304.8)	176	(79.8)
B411-15	15"	(381.0)	202	(91.6)
B411-18	18"	(457.2)	234	(106.1)

B381-B385 WALL LADDER BRACKETS

- Standard finishes: ZN, GRN

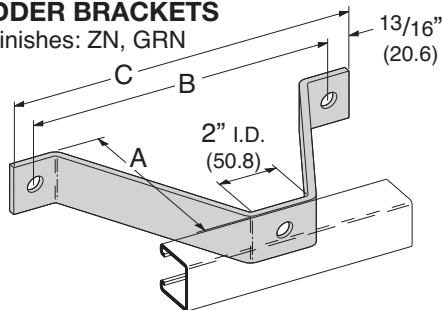

Part No.	A		B		C		Wt./C	
	A	(A)	B	(B)	C	(C)	Lbs.	kg
B381	2 3/8"	(60.3)	6"	(152.4)	7 5/8"	(193.7)	110	(49.9)
B382	4 3/8"	(111.1)	8"	(203.2)	9 5/8"	(244.5)	164	(74.4)
B383	6 3/8"	(161.9)	10"	(254.0)	11 5/8"	(295.3)	200	(90.7)
B384	8 3/8"	(212.7)	12"	(304.8)	13 5/8"	(346.1)	253	(114.7)
B385	10 3/8"	(263.5)	14"	(355.6)	15 5/8"	(396.9)	318	(144.2)

B587-1/2, 3/4 & 1 PIPE COUPLING FITTING

- Safety Factor of 2.5
- Standard finishes: ZN, GRN

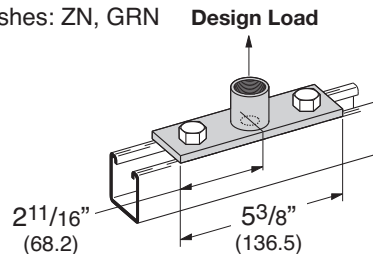

Part No.	For Pipe Size		Wt./C		Design Load	
	For Pipe Size	(A)	Lbs.	kg	Lbs.	kN
B587-1/2	1/2"	(15)	77	(34.9)	1000	(4.45)
B587-3/4	3/4"	(20)	84	(38.1)	1400	(6.23)
B587-1	1"	(25)	105	(47.6)	1900	(8.45)

Reference page 72 for general fitting and standard finish specifications.

Miscellaneous Fittings

B349

TROLLEY BEAM SUPPORT

- Design Load 1200 Lbs. (5.34 kN)
- Safety Factor of 2.5
- Use $\frac{3}{8}$ " x 3" bolts in side hole to clamp strut together (not included)
- Standard finishes: ZN, GRN
- Wt./C 107 Lbs. (48.5 kg)

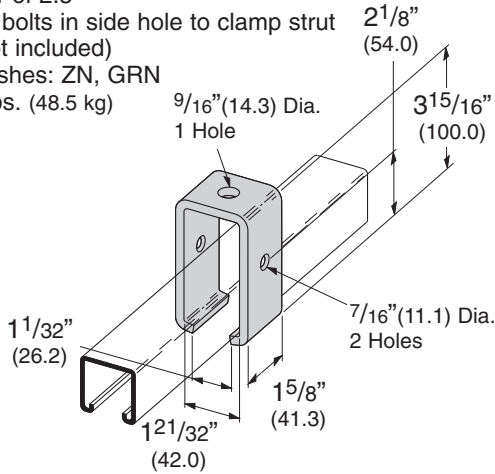

B350

TROLLEY BEAM JOINT SUPPORT

- Design Load 1200 Lbs. (5.34 kN)
- Use $\frac{3}{8}$ " x 3" bolts in side hole to clamp strut together (not included)
- Standard finishes: ZN, GRN
- Wt./C 233 Lbs. (105.7 kg)

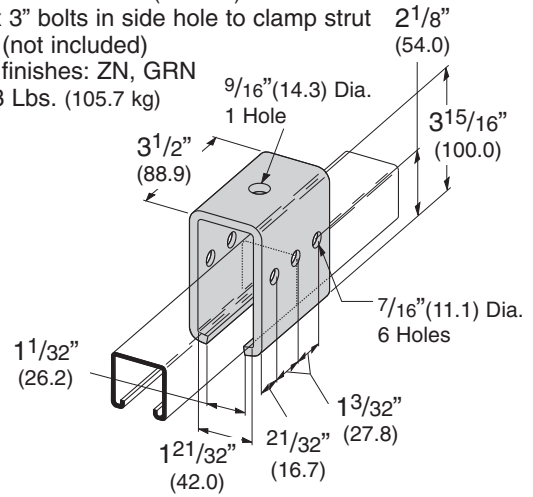

B614

COLUMN SUPPORT FOR B22

- Quick installation (one bolt to tighten)
- Design Load 800 Lbs. (3.56 kN) Slip with Safety Factor of 3
- Use with B22 and B24 Channel
- Sold in pairs
- Standard finish: ZN
- Wt./C 50 Lbs. (22.6 kg)

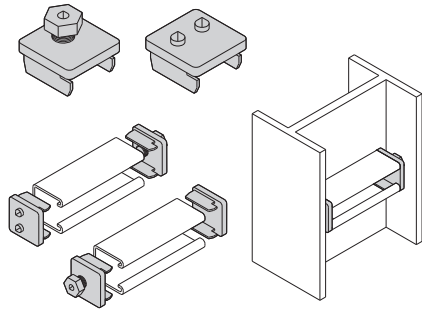

B613

COLUMN SUPPORT FOR B22

- Design Load 800 Lbs. (3.56 kN) Slip with Safety Factor of 3
- Use with B22 and B24 Channel
- Setscrews to be torqued to 19 ft./Lbs
- Sold in pairs
- Standard finishes: ZN, GRN, HDG
- Wt./C 100 Lbs. (45.3 kg)

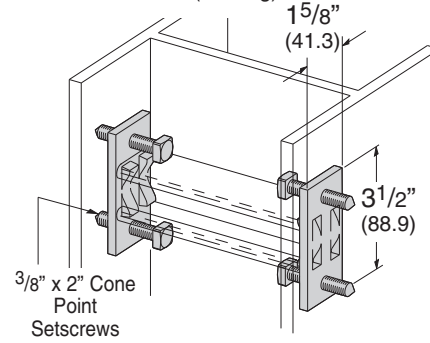

B613A

COLUMN SUPPORT FOR B52

- Design Load 800 Lbs. (3.56 kN) Slip with Safety Factor of 3
- Use with B52 and B54 Channel
- Setscrews to be torqued to 19 ft./Lbs
- Sold in pairs
- Standard finishes: ZN, GRN, HDG
- Wt./C 100 Lbs. (45.3 kg)

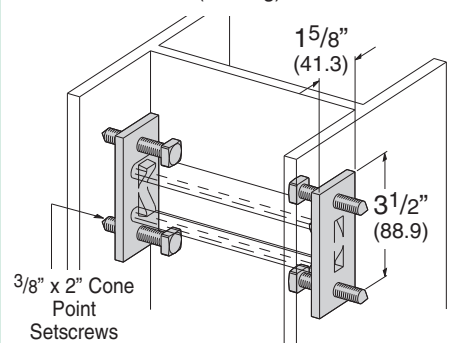

B560

45° STAIR SUPPORT

- Standard finishes: ZN, GRN
- Wt./C 220 Lbs. (99.8 kg)

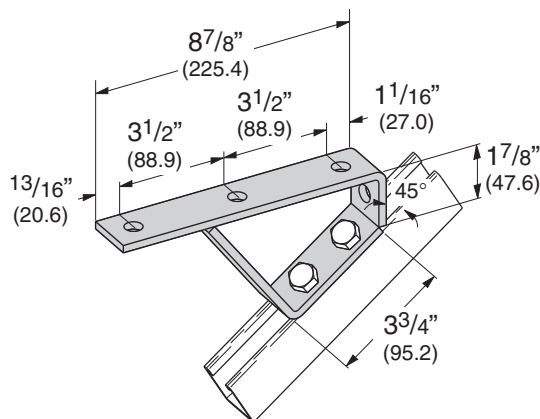

B562

37-1/2° STAIR SUPPORT

- Standard finishes: ZN, GRN
- Wt./C 206 Lbs. (93.4 kg)

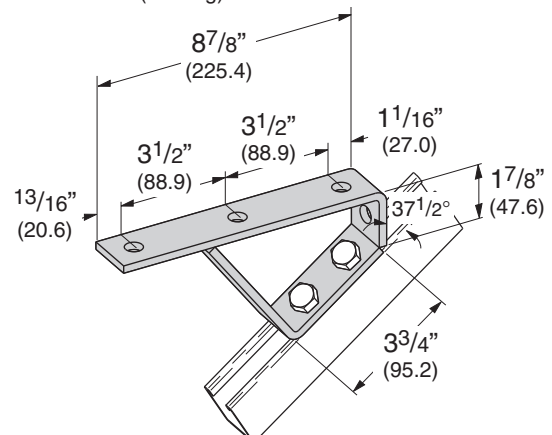

Reference page 72 for general fitting and standard finish specifications.

B376 FOUR BEARING TROLLEY ASSEMBLY

- Safety Factor of 2.5
- Stainless steel ball bearings
- Not for continuous cycling applications
- Standard finishes: ZN
- Wt./C 110 Lbs. (49.9 kg)

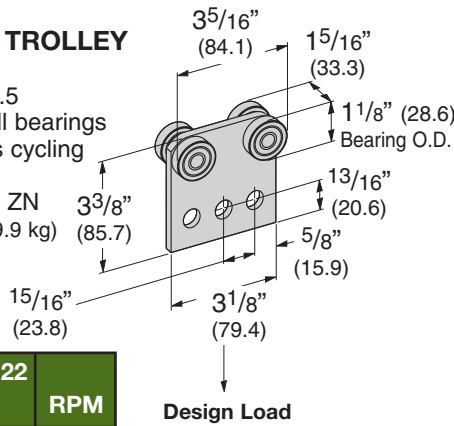

Design Load in B22		
Lbs.	kN	RPM
300	(1.33)	@ 600
450	(2.00)	@ 300
600	(2.67)	@ 100

B377 TWO BEARING TROLLEY ASSEMBLY

- Safety Factor of 2.5
- Stainless steel ball bearings
- Not for continuous cycling applications
- Standard finishes: ZN
- Wt./C 48 Lbs. (21.8 kg)

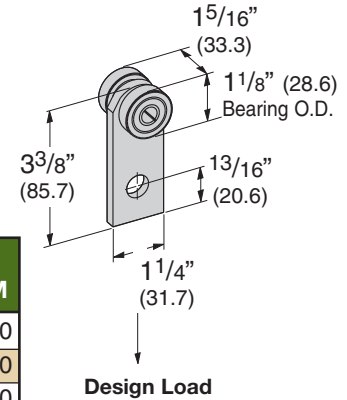

Design Load in B22		
Lbs.	kN	RPM
150	(.67)	@ 600
225	(1.00)	@ 300
437	(1.94)	@ 100

B477 TWO BEARING LIGHT DUTY TROLLEY ASSEMBLY

- Design Load 50 Lbs. (.22 kN)
- Safety Factor of 2.5
- Stainless steel ball bearings
- Not for continuous cycling applications
- Material: 12 Gauge (2.6) ASTM A1011 33,000 PSI min. yield
- Standard finishes: ZN
- Wt./C 30 Lbs. (13.6 kg)

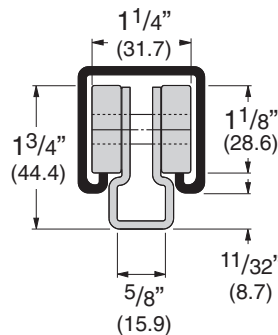

B477P WITH PLASTIC BEARINGS

- Design Load 10 Lbs. (.045 kN)

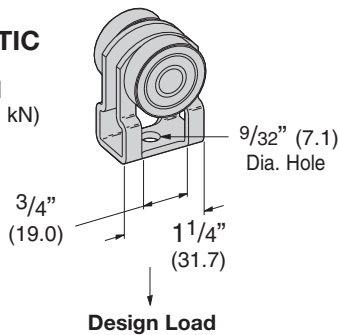

B478 FOUR BEARING LIGHT DUTY TROLLEY ASSEMBLY

- Design Load 100 Lbs. (.44 kN)
- Safety Factor of 2.5
- Stainless steel ball bearings
- Not for continuous cycling applications
- Material: 12 Gauge (2.6) ASTM A1011 33,000 PSI min. yield
- Standard finishes: ZN
- Wt./C 68 Lbs. (30.8 kg)

B478P WITH PLASTIC BEARINGS

- Design Load 20 Lbs. (.090 kN)

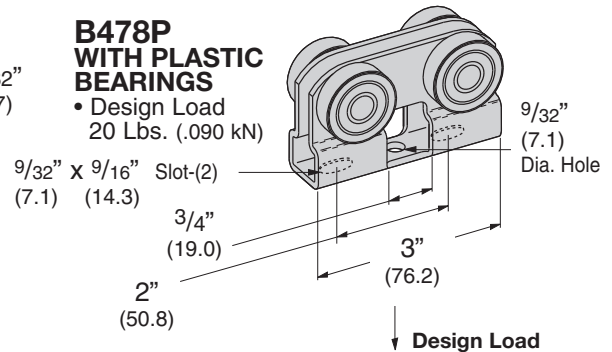

B477H TWO BEARING LIGHT DUTY TROLLEY ASSEMBLY WITH EYE HOOK

- Design Load 50 Lbs. (.22 kN)
- Safety Factor of 2.5
- Stainless steel ball bearings
- Not for continuous cycling applications
- Material: 12 Gauge (2.6) ASTM A1011 33,000 PSI min. yield
- Standard finishes: ZN
- Wt./C 36 Lbs. (16.3 kg)

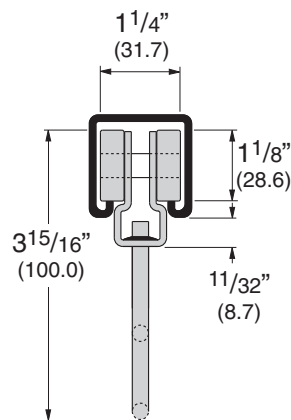

B477HP WITH PLASTIC BEARINGS

- Design Load 10 Lbs. (.045 kN)

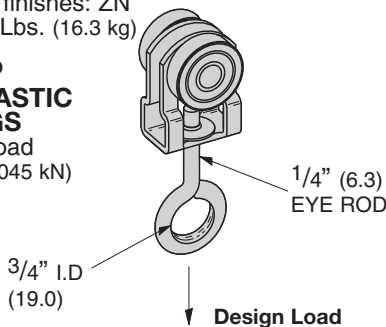

B478H FOUR BEARING LIGHT DUTY TROLLEY ASSEMBLY WITH EYE HOOK

- Design Load 100 Lbs. (.44 kN)
- Safety Factor of 2.5
- Stainless steel ball bearings
- Not for continuous cycling applications
- Material: 12 Gauge (2.6) ASTM A1011 33,000 PSI min. yield
- Standard finishes: ZN
- Wt./C 72 Lbs. (32.6 kg)

B478HP WITH PLASTIC BEARINGS

- Design Load 20 Lbs. (.090 kN)

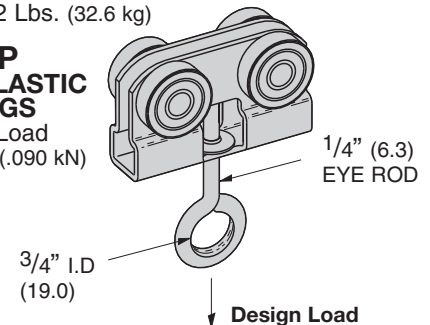

Reference page 72 for general fitting and standard finish specifications.

Miscellaneous Fittings

B203-B206 & B220-B223 CHANNEL END CAPS TYPE X

- Material: ASTM A1011 CS Type B
- Standard finishes: ZN, GRN, HDG, SS4, AL

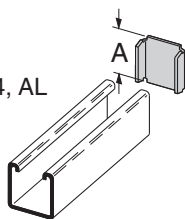

Part No.	Use With	A	(A)	Wt./C	
				Lbs.	kg
B203	B42	1.015	(25.8)	6	(2.7)
B204	B54	.827	(21.0)	5	(2.2)
B205	B22	1.640	(41.6)	10	(4.5)
B206	B32	1.390	(35.3)	8	(3.6)
B220	B52	.827	(21.0)	4	(1.8)
B221	B12	2.452	(62.3)	15	(6.8)
B222	B11	3.265	(82.9)	20	(9.1)
B223	B24	1.640	(41.6)	10	(4.5)

B283-B286 CHANNEL END CAPS

- Material: ASTM A1011 33,000 PSI min. yield
- Standard finishes: ZN, GRN

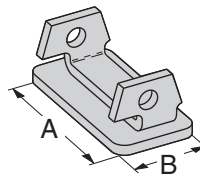

Part No.	Use With	A	(A)	B	(B)	Wt./C	
						Lbs.	kg
B283	B52	1 ¹⁹ / ₃₂ "	(40.5)	2 ⁵ / ₃₂ "	(19.8)	6	(2.7)
B284	B54 & B56	1 ¹⁹ / ₃₂ "	(40.5)	2 ⁵ / ₃₂ "	(19.8)	6	(2.7)
B285	B22	1 ¹⁹ / ₃₂ "	(40.5)	1 ¹⁹ / ₃₂ "	(40.5)	13	(5.9)
B286	B24 & B26	1 ¹⁹ / ₃₂ "	(40.5)	1 ¹⁹ / ₃₂ "	(40.5)	14	(6.3)

B287 & B288 CHANNEL END CAPS

- Material: ASTM A1011 33,000 PSI min. yield
- Standard finishes: ZN, GRN

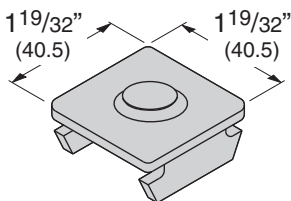

Part No.	Use With	Wt./C	
		Lbs.	kg
B287	B22	13	(5.9)
B288	B24	14	(6.3)

B3322, B3332, B3342, B3352 ANCHOR END CAPS TYPE Y

- Material: ASTM A1011 33,000 PSI min. yield
- Standard finishes: ZN

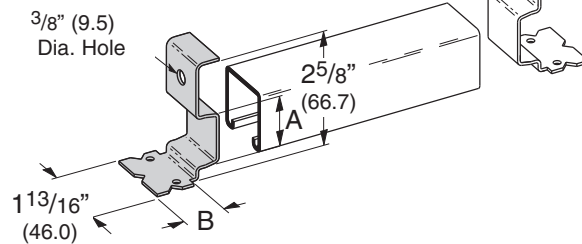

Part No.	Use With	A	(A)	B	(B)	Wt./C	
						Lbs.	kg
B3322	B22I	1.270	(32.2)	1 ³ / ₁₆ "	(30.2)	15	(6.8)
B3332	B32I	1.000	(25.4)	1 ³ / ₁₆ "	(30.2)	15	(6.8)
B3342	B42I	.645	(16.4)	1 ¹ / ₄ "	(31.8)	15	(6.8)
B3352	B52I	.460	(11.7)	1 ⁵ / ₁₆ "	(33.3)	15	(6.8)

B822 PLASTIC END CAP FOR B22 & B24

- Material: Soft White PVC
- Wt./C 3 Lbs. (1.3 kg)
- Available in colors: White (W), Yellow (Y), Black (BLK), Gray (GRY), Green (GRN)

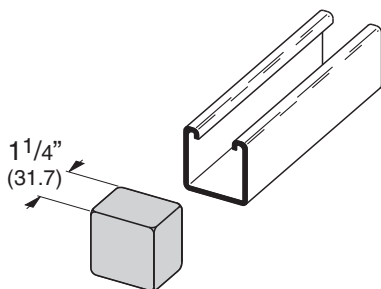

B822A PLASTIC END CAP FOR B22A & B11

- Material: Soft White PVC
- Wt./C 5 Lbs. (2.2 kg)
- Available in colors: White (W), Yellow (Y), Black (BLK), Gray (GRY), Green (GRN)

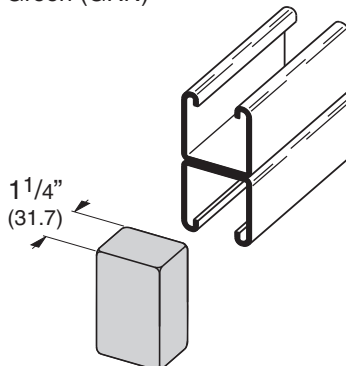

B852 PLASTIC END CAP FOR B52

- Material: Soft White PVC
- Wt./C 2.5 Lbs. (1.1 kg)
- Available in colors: White (W), Yellow (Y), Black (BLK), Gray (GRY), Green (GRN)

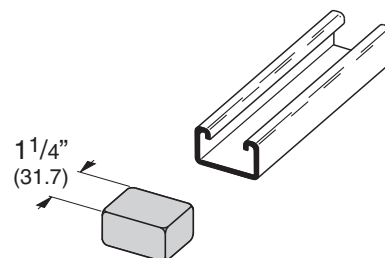

Reference page 72 for general fitting and standard finish specifications.

B823 PROFILE END CAPS

- Material: PVC
- Available in colors: White (W), Yellow (Y), Black (BLK), Gray (GRY), Green (GRN)

Approx. 3/4" deep
(19.0)

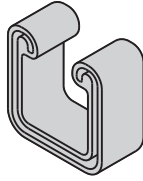

Part No.	Fits Channel Sizes	Wt./C	
		Lbs.	kg
B823-22A	B22A, B24A, B26A	6.9	(3.1)
B823-22	B22, B24, B26	4.1	(1.8)
B823-42	B42	3.8	(1.7)
B823-52	B52, B54, B56	3.5	(1.6)

B825 PLASTIC END CAPS

- Material: Polyurethane
- Available in colors: Gray (GRY), Green (GRN)

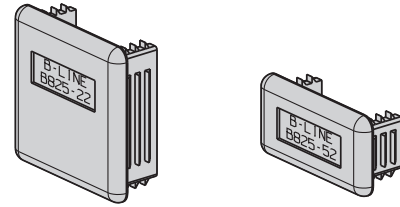

Part No.	Fits Channel Sizes	Wt./C	
		Lbs.	kg
B825-22	B22 & B24	2.0	(0.9)
B825-52	B52 & B54	1.0	(0.4)

Reference page 72 for general fitting and standard finish specifications.