

**BFV201**  
**SQUARE WASHER FOR 3/8" BOLT**

- Material: Injection Molded Glass Reinforced Polyurethane

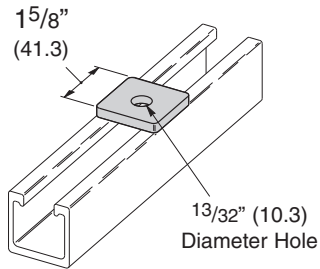

**BFV202**  
**SQUARE WASHER FOR 1/2" BOLT**

- Material: Injection Molded Glass Reinforced Polyurethane

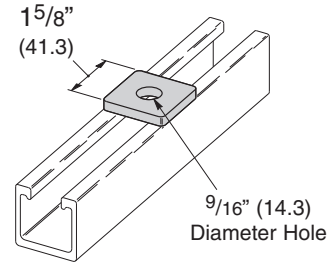

**BFV340**  
**TWO HOLE FLAT PLATE**

- Material: Injection Molded Glass Reinforced Polyurethane

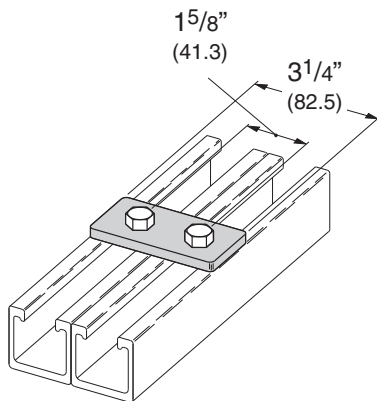

**BFV129**  
**TWO HOLE SPLICE PLATE**

- Material: Injection Molded Glass Reinforced Polyurethane

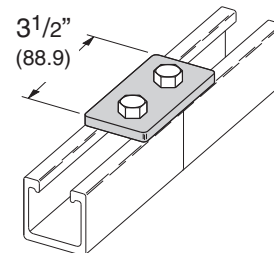

**BFV141**  
**THREE HOLE FLAT PLATE**

- Material: Injection Molded Glass Reinforced Polyurethane

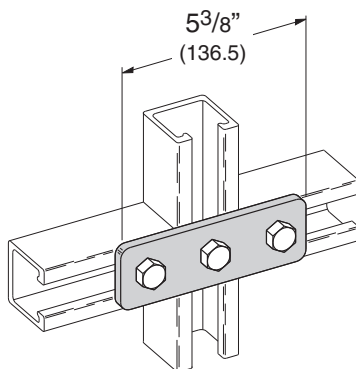

**BFV557**  
**THREE HOLE FLAT PLATE**

- Material: Injection Molded Glass Reinforced Polyurethane

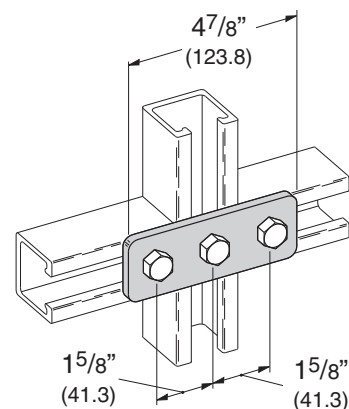

Reference page 182 for general fitting specifications.